



HEP *ower for light*

International
Terminal
www.hep.com



Catalog 2016-2017

Benefits of choosing HEP products
Performance and Reliability



HEP Group was founded in 2002. HEP Group Headquarters—HEP Tech Co., Ltd. is approved by Taiwan Gre Tai Securities Market (GTSM) to list as an over-the-counter OTC market company in 2011, which ensures that HEP Tech Co., Ltd. is a steady corporation and has a positive influence on public.

In past a decade HEP specialized in innovating and manufacturing environment-friendly, energy-saving, delicate electronic lighting control gears for industrial and commercial purposes. All HEP products are engineered in compliance with the highest safety and performance standards, as evidenced by complete certifications from ENEC, UL, CSA and CCC. Productions also meet with global regulatory safety and environment protection norms, such as RoHS, REACH and WEEE.

In pursuit of corporate social responsibility—the ultimate energy efficiency, lighting quality and sustainable environment, HEP constantly dedicates to develop the most advanced green lighting electronics. Featured products, including Daylight Control, Electronic Dimmable Control Ballast, Electronic HPS Dimmable Control Ballast and LED Driver, will fit the high requirement of the corporate goals. HEP never stops maximizing lighting performance throughout excellent innovation and continuously supporting a greener world.

HEP—High-reliability Electronic Performance is our commitment to customers with value-added quality and services. As a strategic partner, we not only promise to meet our customer's needs, but also look forward to becoming an engine of innovation.



comply with RoHS standards

LEDriver & Control unit LEDriver & Steuerungen	1
Electronic Control Gear Elektronische Vorschaltgeräte	53
Emergency Lighting Unit Notlichteinsätze	63
HID Control Gear HID Vorschaltgeräte	69

G2+ series - Compact LED Driver

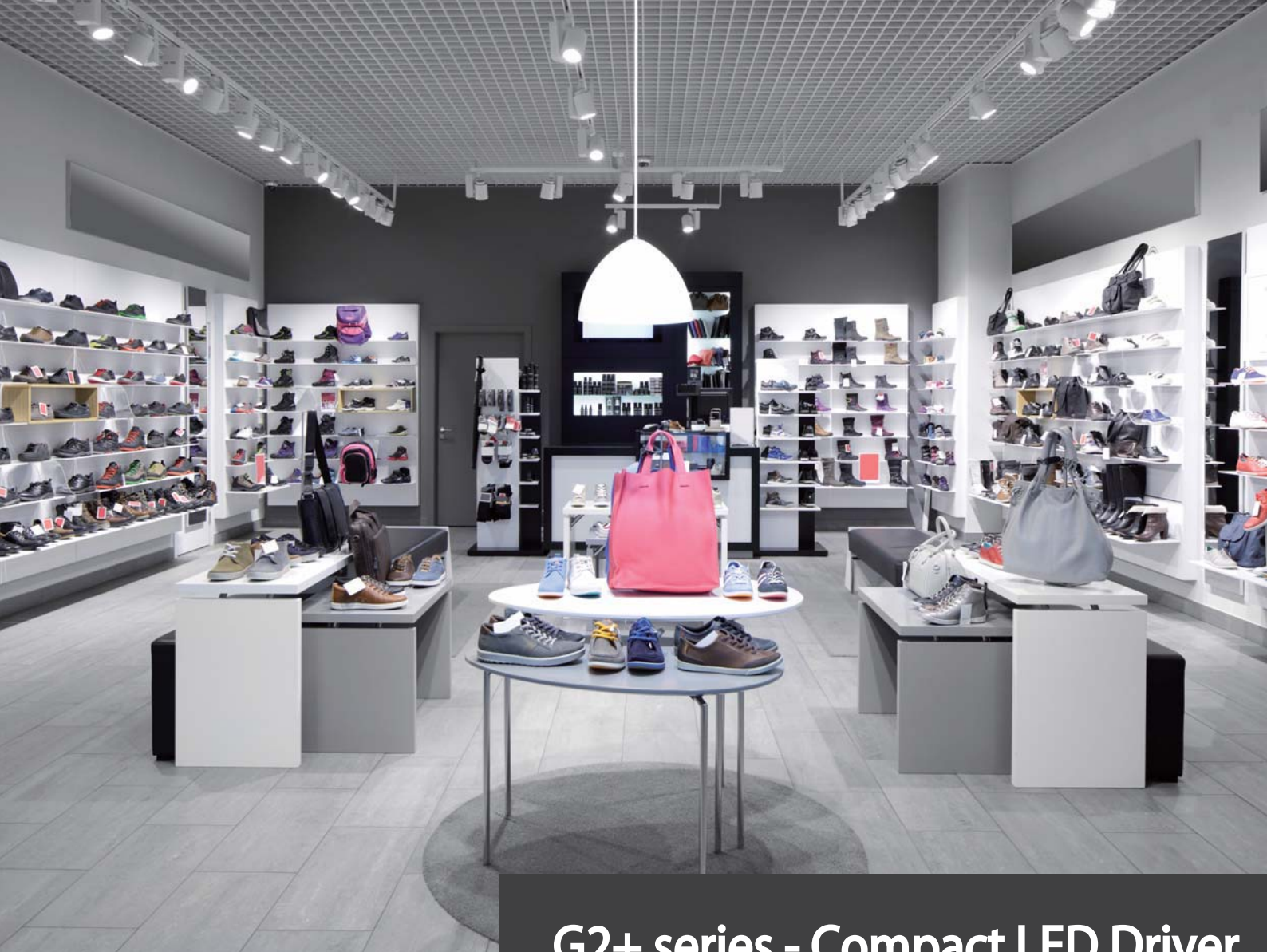

G2+ series - Compact LED Driver

Tunable G2+ Drivers Deliver Luminaires with Benefits



Tunable G2+ Drivers Deliver Luminaires with Benefits

Multiple output current

One driver offering 3 types of output current helps to reduce inventory costs.

Low ripple current design

It makes direct lighting perform superior quality on job sites, especially for museum, library, shopping mall, office or commercial applications.

Flexibility of usage

Simply and easily by clicking on side covers as an independent unit, allow the usages more flexible.

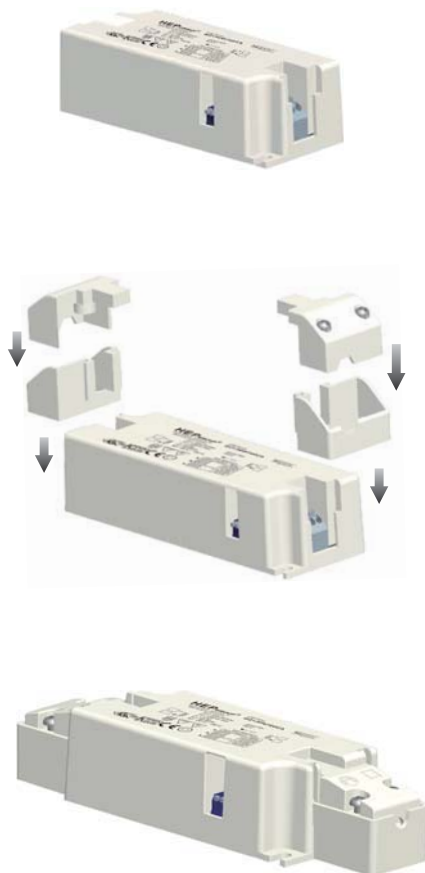

How to adjust output current ?

Quickly moving two dip-switched up/downward within 3 kind of combinations to select the desired output current anytime, if needed.

G2 +	Major current combination					
20W		250mA		350mA		500mA
30W		500mA		600mA		700mA
38W		700mA		800mA		900mA
50W		900mA		1050mA		1200mA

Application :

- By adding side covers the built-in type simply easy as an independent unit.
- Selectable O/P currents ranged from 250 to 500mA, 500 to 700mA, 700 to 900mA and 900 to 1200mA in steps of 50mA.
- 3 O/P currents available for choice, please contact with HEP sales for your customized combo.



Applicable fixture : Spotlights, Floor light, Tracking light



Applicable site : Downlight, Ceiling light, Spotlight, Tracking light

Models



Model	Output Current (mA)	Output Voltage (V)	Output Power (W)	Input Voltage (V)	Input Current (A)	Power Factor	Efficiency (%)	Ripple Current (%)	Dimension LxWxH (mm)
G2+ 20W500CA	250	30-42	7.5-10.5	220-240	0.07	0.9	83	±4	(A)97 x 43 x 30 (B)147 x 43 x 30
	350		10.5-14.5		0.09				
	500		15-21		0.12				
G2+ 30W700CA	500	30-42	15-21	220-240	0.13	0.9	85	±4	(A)97 x 43 x 30 (B)147 x 43 x 30
	600		18-25		0.15				
	700		21-29.5		0.17				
G2+ 38W900CA	700	30-42	21-29.5	220-240	0.17	0.9	86	±4	(A)97 x 43 x 30 (B)147 x 43 x 30
	800		24-33.5		0.18				
	900		27-38		0.21				
G2+ 50W1200CA	900	30-42	27-38	220-240	0.21	0.9	86	±4	(A)135 x 43 x 30 (B)185 x 43 x 30
	1050		31.5-44		0.24				
	1200		36-50.5		0.28				

* Output Current is adjustable ; ENEC Certified in steps of 50mA.

A.

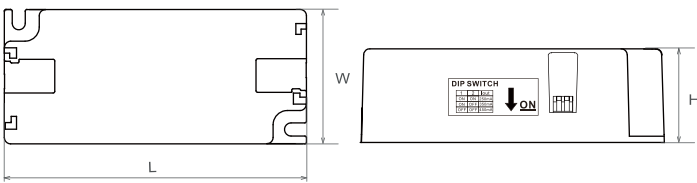

B.

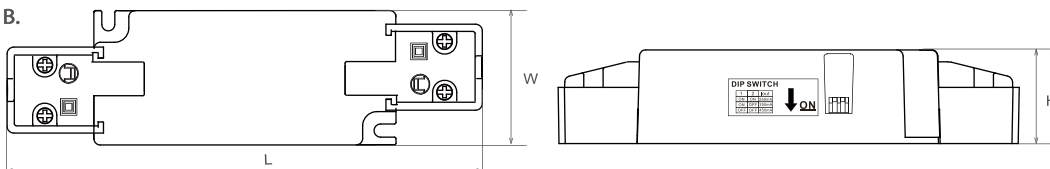

Wire dimension

Input / Output : Power cord

Cable Cross Section : 0.5-1.5 □ / AWG 20-16





CubePower LED Driver

Drive any
desired output current

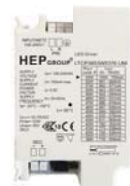



Drive any desired output current

Using desired O/P current to get better Price-Wise performance ratio in your lighting fixture.

Drive full range of output current with ENEC certification ready - to shorten development time of a new luminaires

Shipment of any assigned O/P-current driver within 2 weeks - to reduce stock cost

Low ripple current less than $\pm 5\%$ - to meet the future lighting trend

Features

- O/P wattage range of 11-53W
- O/P voltage range of 18-80V
- O/P current range of 250-1000mA
- Efficiency > 80%
- Power Factor > 0.9
- ENEC certification

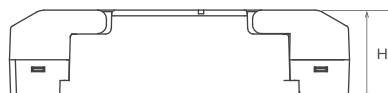
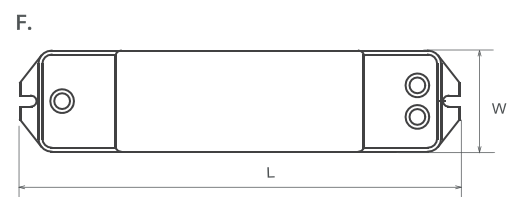
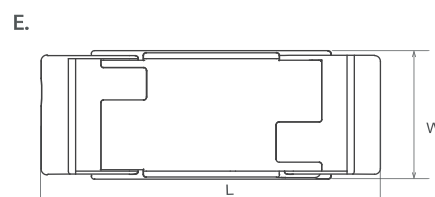
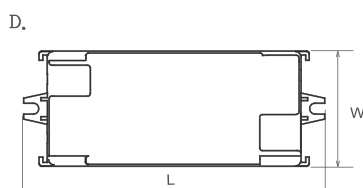
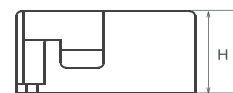
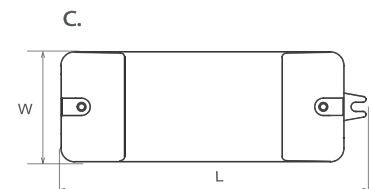
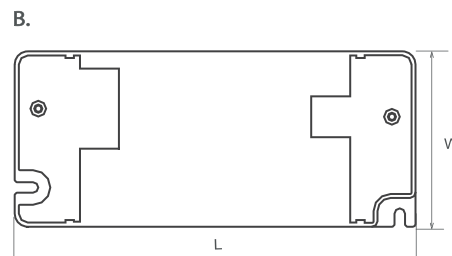
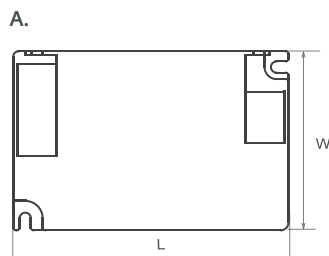



Generation1 - Universal series

Watts (W)	Output Current (mA)	Output Voltage (V)	Model	Input Voltage (V)	Efficiency (%)	Power Factor	Dimension LxWxH(mm)	Approbations
21-30	700-1500	20-30	LTCP2130W2030(-Z) UNI	100-277	80	0.90	(A)Built-in : 103x67x30.5 (B)Independent : 153x67x30.5	ENEC
21-30	490-1000	30-42.86	LTCP2130W3042(-Z) UNI	100-277	80	0.90	(A)Built-in : 103x67x30.5 (B)Independent : 153x67x30.5	ENEC
21-30	350-700	42.86-60	LTCP2130W4260(-Z) UNI	100-277	80	0.90	(A)Built-in : 103x67x30.5 (B)Independent : 153x67x30.5	ENEC
31-40	775-1500	26.67-40	LTCP3140W2640(-Z) UNI	100-277	80	0.90	(A)Built-in : 103x67x30.5 (B)Independent : 153x67x30.5	ENEC
31-40	504-960	41.67-61.54	LTCP3140W4161(-Z) UNI	100-277	80	0.90	(A)Built-in : 103x67x30.5 (B)Independent : 153x67x30.5	ENEC
38-53	716-1500	35.5-53	LTCP3853W3553(-Z) UNI	100-240	85	0.90	(A)Built-in : 103x67x30.5 (B)Independent : 153x67x30.5	ENEC
38-53	500-1000	53-76	LTCP3853W5376(-Z) UNI	100-240	85	0.90	(A)Built-in : 103x67x30.5 (B)Independent : 153x67x30.5	ENEC

Applicable fixture : Downlight, OLED



Application site : Private office, Boardroom, Public space, Retail environment



Generation2 - Low ripple series (Ripple Current <math>< \pm 5\% </math>)

Watts (W)	Output Current (mA)	Output Voltage (V)	Model	Input Voltage (V)	Dimming Type	Dimming Range (%)	Efficiency (%)	Power Factor	Dimension LxWxH(mm)	Approbations
20	250-800	18-57	LNCC20WXXXLR-Z	220-240	N/A	N/A	84	0.90	(C)111x40x26.5	ENEC
30	500-1000	21-60	LBCC30WXXXLR LBCC30WXXXLR-Z	220-240	N/A	N/A	85	0.90	(D)Built-in : 115x44x30 (E)Independent : 137.4x44x30	ENEC
30	500-1000	21-60	LTCC30WXXXLR LTCC30WXXXLR-Z	220-240	N/A	N/A	85	0.90	(A)Built-in : 103x67x30.5 (B)Independent : 153x67x30.5	ENEC
40	500-1000	28-80	LTCC40WXXXLR LTCC40WXXXLR-Z	220-240	N/A	N/A	85	0.90	(A)Built-in : 103x67x30.5 (B)Independent : 153x67x30.5	ENEC

* ENEC certified in steps of 25mA



Generation3 - Dimming series

Watts (W)	Output Current (mA)	Output Voltage (V)	Model	Input Voltage (V)	Dimming Type	Dimming Type (%)	Efficiency (%)	Power Factor	Dimension LxWxH(mm)	Approbations
20	300-700	18-60	LLTC20WXXXLR-Z	220-240	Triac	10-100	80	0.90	(F)167x38.4x29.8	ENEC
20	300-700	18-60	LLPC20WXXXLR-Z	220-240	PWM	10-100	80	0.90	(F)167x38.4x29.8	ENEC
20	300-700	18-60	LLASC20WXXXLR-Z	220-240	AirDim	10-100	80	0.90	(F)167x38.4x29.8	ENEC
30	500-1000	21-60	LBTC30WXXXLR LBTC30WXXXLR-Z	220-240	Triac	10-100	85	0.90	(D)Built-in : 115x44x30 (E)Independent : 137.4x44x30	ENEC
30	500-1000	21-60	LTTC30WXXXLR LTTC30WXXXLR-Z	220-240	Triac	10-100	85	0.90	(A)Built-in : 103x67x30.5 (B)Independent : 153x67x30.5	ENEC
30	500-1000	21-60	LTPC30WXXXLR LTPC30WXXXLR-Z	220-240	PWM	10-100	85	0.90	(A)Built-in : 103x67x30.5 (B)Independent : 153x67x30.5	ENEC
30	500-1000	21-60	LTASC30WXXXLR LTASC30WXXXLR-Z	220-240	AirDim	10-100	85	0.90	(A)Built-in : 103x67x30.5 (B)Independent : 153x67x30.5	ENEC
40	500-1000	28-80	LTTC40WXXXLR LTTC40WXXXLR-Z	220-240	Triac	10-100	85	0.90	(A)Built-in : 103x67x30.5 (B)Independent : 153x67x30.5	ENEC
40	500-1000	28-80	LTPC40WXXXLR LTPC40WXXXLR-Z	220-240	PWM	10-100	85	0.90	(A)Built-in : 103x67x30.5 (B)Independent : 153x67x30.5	ENEC
40	500-1000	28-80	LTASC40WXXXLR LTASC40WxxxLR-Z	220-240	AirDim	10-100	85	0.90	(A)Built-in : 103x67x30.5 (B)Independent : 153x67x30.5	ENEC

* ENEC certified in steps of 25mA



Constant voltage Linear LED Driver

Exceptional Flexibility
Carrying Out
Versatility of Linear LED System





Exceptional Flexibility Carrying Out Versatility of Linear LED System

Features

- High efficiency
- Low power loss
- Low profile in 21mm height
- Full range 30W ~ 320W
- 1-10V / 2-step dim availability
- Slim design for versatile uses
- Over temperature and overload protection
Protection SELV



Dimension

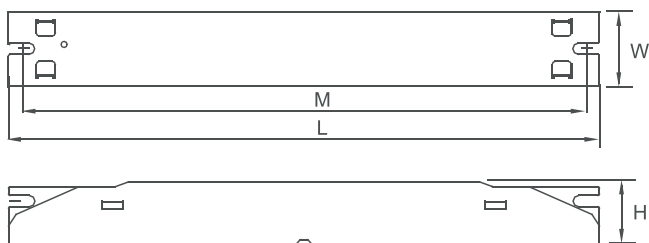

m/m	A	B	C	D	E	F	G	H
L	235	280	280	360	360	425	425	425
W	30	30	30	30.4	30	45	45	48
H	21	21	27.5	21.5	26	21.5	24	35
M	218.5	265	265	342.8	342.8	415	415	413

Watts (W)	Output Voltage (V)	Output Current (mA)	Model	Input Voltage (V)	Dimming Type	Dimming Range (%)	Efficiency (%)	Power Factor	Dimension LxWxH(mm)	Approbations
30	24	1250	LAV30W24V	220-240	N/A	N/A	83	0.90	(A)235x30x21	ENEC*
30	24	1250	LAV30W24V1C	220-240	1-10V	3-100	83	0.90	(A)235x30x21	ENEC*
60	24	2500	LAV60W24V	220-240	N/A	N/A	87	0.95	(B)280x30x21	ENEC
60	24	2500	LAV60W24V1C	220-240	1-10V	10-100	87	0.95	(B)280x30x21	ENEC
46	48	960	LBV46W48 UNI	100-277	N/A	N/A	85	0.95	(C)280x30x27.5	cRU,ENEC
100	24	4166	LAV100W24VS	220-240	N/A	N/A	91	0.95	(D)360x30.4x21.5	ENEC*
100	24	4166	LAV100W24VS1C	220-240	1-10V	1-100	91	0.95	(D)360x30.4x21.5	ENEC*
46	48	960	LPC46W48V1C UNI	100-277	0/1-10V	0-100	80	0.95	(E)360x30x26	cRU,ENEC
70	48	1460	LCV70W48 UNI	100-277	N/A	N/A	85	0.95	(E)360x30x26	cRU,ENEC
150	24	6250	LAV150W24V	220-240	N/A	N/A	92	0.98	(F)425x45x21.5	ENEC*
150	24	6250	LAV150W24V1C	220-240	1-10V	1-100	92	0.98	(F)425x45x21.5	ENEC*
200	24	8300	LAV200W24V	220-240	N/A	N/A	93	0.98	(G)425x45x24	ENEC*
200	24	8300	LAV200W24V1C	220-240	1-10V	1-100	93	0.98	(G)425x45x24	ENEC*
250	24	10400	LAV250W24V	220-240	N/A	N/A	92	0.98	(H)425x48x35	ENEC*
250	24	10400	LAV250W24V1C	220-240	1-10V	2-100	92	0.98	(H)425x48x35	ENEC*
320	24	13300	LAV320W24V	220-240	N/A	N/A	93	0.98	(H)425x48x35	ENEC*
320	24	13300	LAV320W24V1C	220-240	1-10V	2-100	93	0.98	(H)425x48x35	ENEC*



Linear LED Strip/Tube Driver

Driving LED seamlessly to linear fluorescent fixture





Driving LED seamlessly to linear fluorescent fixture

Features

- Universal I/P voltage 120-277V
- Full output range- 22W to 50W
- Power Factor >0.9 @ 120V and 277V
- High efficiency performance > 85%
- Tc max. temperature up to 90°C
- Various dimming/control modes for option
- Triac, 0-10V / 1-10V, Dali, Zigbee (wireless)
- Lifetime 50,000hrs ; Warranty 5 years
- **UL** **CE** **RoHS**



Dimming/control modes

Two-wire Dim

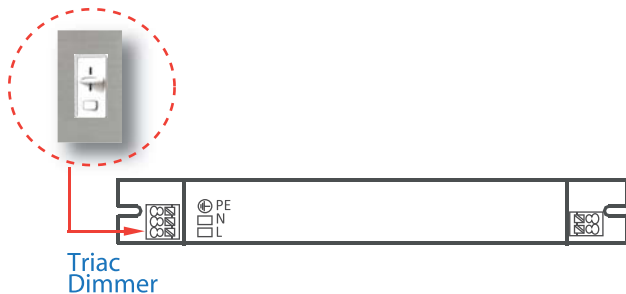

- Triac dim smoothly with no flickering of 100%~10%
- Several popular-brand dimmers complied for quick entry on retrofit and new construction

Low-voltage Dim

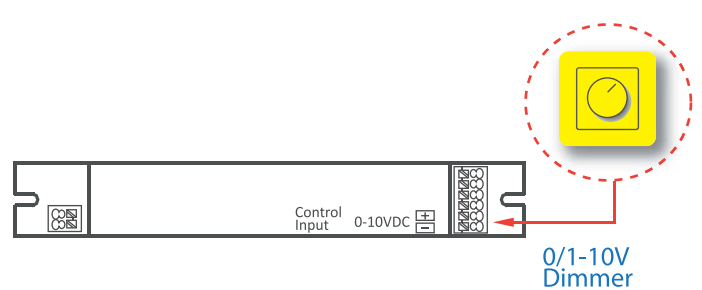

- 0/1-10V dim of 100%~10% suitable for current sink & current source
- 0/1-10V mode easily connected with a light or occupancy sensor for energy saving

RSET Function

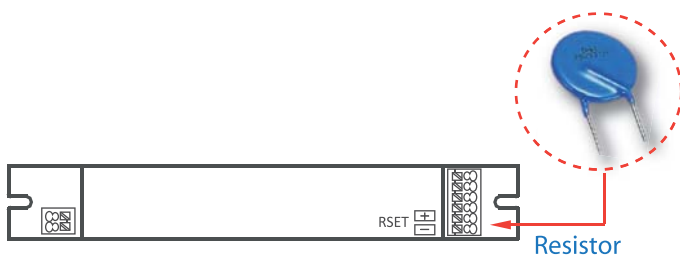

- Single driver tunes output current from 100% to 46% via resistor setting (RSET)
- Make SKUs minimized, less stock required

DALI/Wireless Control

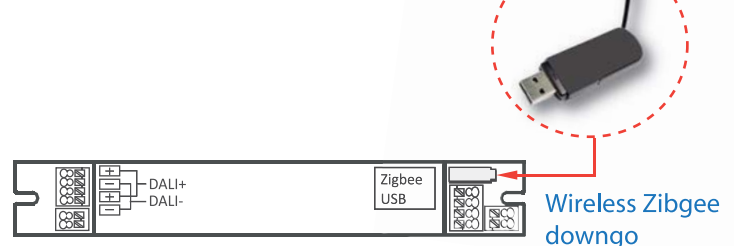

- Dali 2-channel driver programs O/P current of 350mA~1050mA, precisely dims light of 1%~100%, makes LED color-temperature tuneable
- Dali control integrated with Zigbee interface makes commercial building smart

Applicable fixture : Linear ballast type ideal for 2x2'/2x4'/1x4' Troffer, LED Tube, LED strip



Application site : Private office, Boardroom, Public space, Healthcare, Classroom, Cafeteria, Library and Retail environment

Constant Current LED driver



Output Current (mA)	Output Voltage (V)	Watts (W)	Model	Input Voltage (V)	Dimming Type	Control	Dimming Range (%)	Efficiency (%)	Dimension LxWxH(mm)	Approbations
460	36-46	21	LAC22W460 120V	120	N/A	N/A	N/A	85	(A)235x30x26	CE
460	36-46	21	LATC22W460 120V	120	Triac	N/A	10-100	85	(A)235x30x26	CE
150	230-550	12-33	* LBD45W150 UNI	120-277	0-10V	N/A	18-100	80	(B)360x30x26	cRU
180	170-410	15.5-37	* LBD45W180 UNI	120-277	0-10V	N/A	18-100	80	(B)360x30x26	cRU
210	65-450	12-48	* LBD45W210 UNI	120-277	0-10V	N/A	18-100	80	(B)360x30x26	cRU
240	65-450	12-48	* LBD45W240 UNI	120-277	0-10V	N/A	18-100	80	(B)360x30x26	cRU
150/210/240	65-550	12-48	* LBD45W240DPS UNI	120-277	0-10V	N/A	18-100	80	(B)360x30x26	cRU
500	45-55	27	LAC27W500-1C UNI	120-277	0/1-10V	N/A	10-100	82	(B)360x30x26	cRU
980	27-46	45	LAC45W920RT UNI	120-277	N/A	RSET	N/A	87	(B)360x30x26	cRU
980	27-46	45	LAC45W920RT-1C UNI	120-277	0/1-10V	RSET	10-100	87	(B)360x30x26	cRU
1000	27-43	45	LAC45W1000RT-1C UNI	120-277	0/1-10V	RSET	10-100	85	(B)360x30x26	cRU
1050	30-43	45	LAC45W1050RT-1C UNI	120-277	0/1-10V	RSET	10-100	85	(B)360x30x26	cRU
1050	30-43	45	LAC45W1050RT UNI	120-277	N/A	RSET	N/A	85	(B)360x30x26	cRU
600-1050	20-70	45	LADC50W1050MZIB-2C UNI	100-277	DALI	Zigbee/DALI	1-100	86	(C)360x37.1x27	CE

* : Dimming LED driver made for UL type A fixture

Dimension

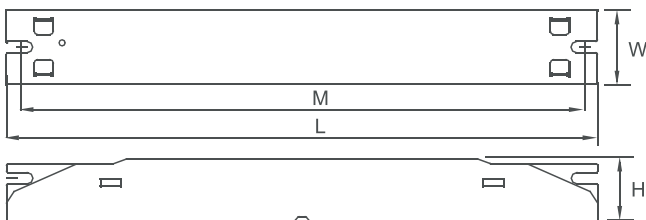

m/m	A	B	C
L	235	360	360
W	30	30	37.1
H	26	26	27
M	218.5	342.8	343.5



IP67 Constant Voltage LED Driver

Enabling Outdoor LED solutions





Enabling Outdoor LED solutions

Features

- Universal input mains 100~240VAC
- Sustainable constant DC voltage output- 12, 24V
- Supports consistent LED lumen control
- Full output power series- 18W/30W/40W/60W/100W/150W/160W/250W
- Overload protection / Overheat cut-off
Short & Open circuit proof
- SELV and hot-wiring capability
- IP67 dust & waterproof
- Compact alloy casing with ease of design-in
- Fixture type : LED wash wall light, outdoor LED strip
- Applicable site : Outdoor wall lamp, garden light

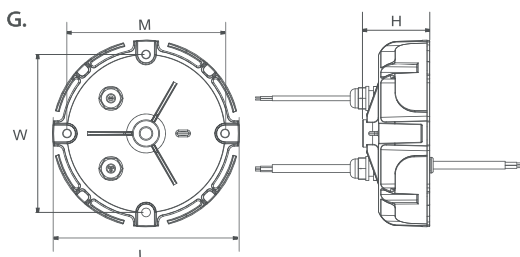
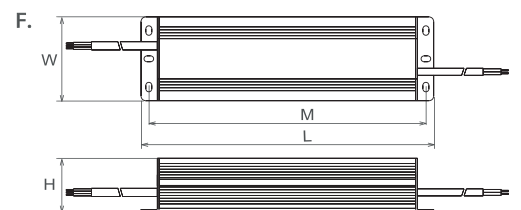
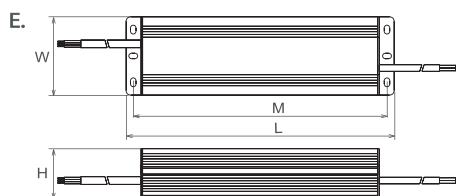
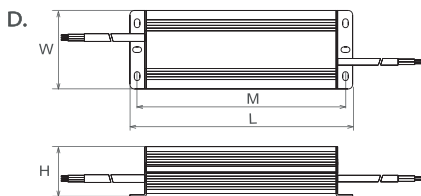
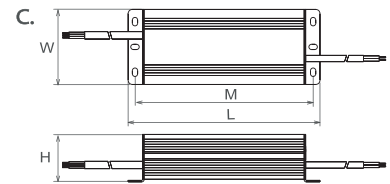
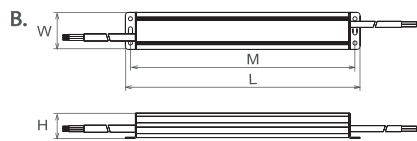
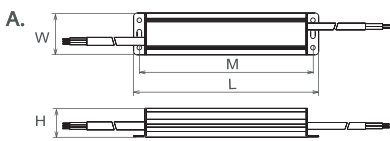



Non-Dim

Watts (W)	Output Voltage (V)	Output Current (A)	Model	Input Voltage (V)	Efficiency (%)	Power Factor	Dimension L/M/W/H(mm)	Approbations
18	12	1.5	LEXV18W12	100-240	78	0.55C	(A)162/152/37/25	TUV
18	24	0.75	LEXV18W24	100-240	80	0.55C	(A)162/152/37/25	TUV
30	12	2.5	LEXV30W12	100-240	78	0.95	(B)232/222/37/25	TUV
30	24	1.25	LEXV30W24	100-240	80	0.95	(B)232/222/37/25	TUV
40	12	3.3	LEXV40W12	100-240	78	0.95	(B)232/222/37/25	TUV
40	24	1.67	LEXV40W24	100-240	80	0.95	(B)232/222/37/25	TUV
60	12	5	LEXV60W12	100-240	84	0.97	(C)182/169/71.2/45	TUV
60	24	2.5	LEXV60W24	100-240	86	0.97	(C)182/169/71.2/45	TUV
100	12	8.3	LEXV100W12	100-240	84	0.97	(D)202/189/71.2/45	TUV
100	24	4.17	LEXV100W24	100-240	85	0.97	(D)202/189/71.2/45	TUV
150	12	12	LEXV150W12	100-240	86	0.95	(E)244/231/71.2/45	TUV
150	24	6.25	LEXV150W24	100-240	88	0.95	(E)244/231/71.2/45	TUV
250	12	20.83	LEXV250W12	100-240	88	0.95	(F)252/239/90/44.5	TUV
250	24	10.42	LEXV250W24	100-240	88	0.95	(F)252/239/90/44.5	TUV
150	24	6.67	LRXV160W24	100-240	90	0.97	(G)151.7/132/132/66.5	CE
250	24	10.4	LRXV250W24	100-240	92	0.98	(G)191.5/162/162/69	CE

Dimming

Watts (W)	Output Voltage (V)	Output Current (A)	Model	Input Voltage (V)	Dimming Type	Dimming Range (%)	Efficiency (%)	Power Factor	Dimension L/M/W/H(mm)	Approbations
160	24	6.66	LRXV160W241C	100-240	1-10V	1-100	90	0.97	(G)151.7/132/132/66.5	CE
250	24	10.4	LRXV250W241C	100-240	1-10V	1-100	92	0.98	(G)191.5/162/162/69	CE



Triac Dimming LED Driver

Make dimming easier
when, where job site needed

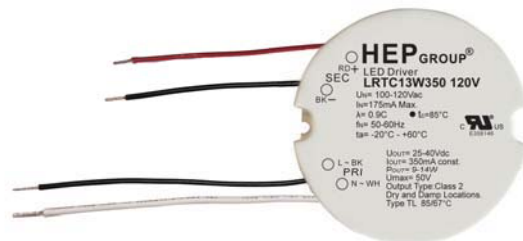



Making dimming so easy when and where job site needed

TRIAC Dimming Control - Make Dimming Easier

Using appropriate lighting level only when and where the job sites need it, energy management will become a major source of savings for your facility. Controllable LED driver allows business to make next step forward in energy savings.

Triac dimming control represents an easy & cost-effective solution to anywhere adjustment of light level is required but control leads are not already installed. Simply with HEP Triac dimming devices, it is so easy to bring LED dimming anywhere without the need for additional control leads and enjoy ultra flexibility & control as well over every environment.



Dimension

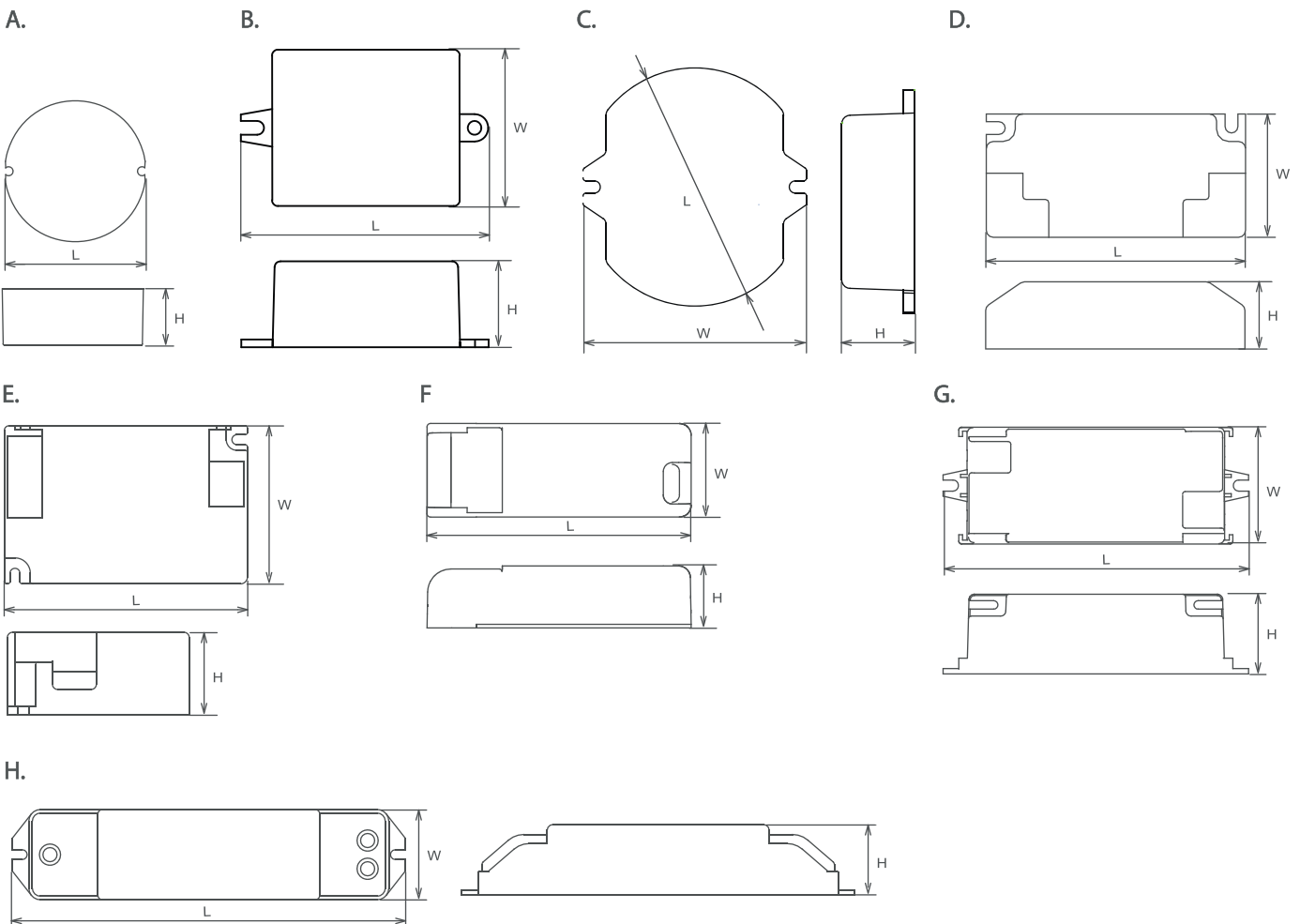

Ouput Current (mA)	Ouput Voltage (V)	Watts (W)	Model	Input Voltage (V)	Dimming Type	Dimming Range (%)	Efficiency (%)	Power Factor	Dimension LxWxH(mm)	Approbations
190	33-40	8	LRTC9W200 120V	100-120	Triac	10-100	78	0.90	(A) ϕ 55x22	cRU
350	18-26	9	LRTC9W350 120V	100-120	Triac	10-100	78	0.90	(A) ϕ 55x22	cRU
500	13-18.5	9	LRTC9W500 120V	100-120	Triac	10-100	78	0.90	(A) ϕ 55x22	cRU
700	10-13	9	LRTC9W700 120V	100-120	Triac	10-100	78	0.90	(A) ϕ 55x22	cRU
350	25-40	13	LRTC13W350 120V	100-120	Triac	10-100	80	0.90	(A) ϕ 65x27	cRU
500	18-26	13	LRTC13W500 120V	100-120	Triac	10-100	80	0.90	(A) ϕ 65x27	cRU
700	13-18.5	13	LRTC13W700 120V	100-120	Triac	10-100	80	0.90	(A) ϕ 65x27	cRU
150	33-43	6	LSTC10W150P	220-240	Triac	10-100	80	0.90	(B) 63.3x40x23	ENEC *
200	33-43	8	LSTC10W200P	220-240	Triac	10-100	80	0.90	(B) 63.3x40x23	ENEC *
250	33-43	10	LSTC10W250P	220-240	Triac	10-100	80	0.90	(B) 63.3x40x23	ENEC *
350	13-27	9	LSTC10W350P	220-240	Triac	10-100	80	0.90	(B) 63.3x40x23	ENEC *
500	12-21	10	LSTC10W500P	220-240	Triac	10-100	80	0.90	(B) 63.3x40x23	ENEC *
500	21-30	15	LSTC15W500P	220-240	Triac	10-100	80	0.80	(B) 79x43x27	CE
700	8-15	10	LSTC10W700P	220-240	Triac	10-100	80	0.90	(B) 63.3x40x23	ENEC *
700	13-21	15	LSTC15W700P	220-240	Triac	10-100	80	0.80	(B) 79x43x27	CE
700	28-40	28	LCC30W700-OS 120V	120	Triac	10-100	85	0.90	(C) 79.8x78.1x25.4	cRU
200	29-44	8	LMTC10W200-Z	220-240	Triac	10-100	75	0.90	(D) 85x40.4x22	ENEC
250	26-40	10	LMTC10W250-Z	220-240	Triac	10-100	75	0.90	(D) 85x40.4x22	ENEC
300	26-43	12	LMTC15W300-Z	220-240	Triac	10-100	75	0.90	(D) 85x40.4x22	ENEC
350	11-16	6	LMTC6W350-Z	220-240	Triac	10-100	73	0.90	(D) 85x40.4x22	ENEC *
350	17-29	10	LMTC10W350-Z	220-240	Triac	10-100	75	0.90	(D) 85x40.4x22	ENEC
350	26-43	15	LMTC15W350-Z	220-240	Triac	10-100	75	0.90	(D) 85x40.4x22	ENEC
450	12-20	9	LMTC10W450-Z	220-240	Triac	10-100	75	0.90	(D) 85x40.4x22	ENEC
450	18-30	13	LMTC15W450-Z	220-240	Triac	10-100	75	0.90	(D) 85x40.4x22	ENEC
500	12-20	10	LMTC10W500-Z	220-240	Triac	10-100	75	0.90	(D) 85x40.4x22	ENEC
500	18-30	15	LMTC15W500-Z	220-240	Triac	10-100	75	0.90	(D) 85x40.4x22	ENEC
600	8.5-14.5	8	LMTC10W600-Z	220-240	Triac	10-100	75	0.90	(D) 85x40.4x22	ENEC
600	13-21	12	LMTC15W600-Z	220-240	Triac	10-100	75	0.90	(D) 85x40.4x22	ENEC
700	8.5-14.5	10	LMTC10W700-Z	220-240	Triac	10-100	75	0.90	(D) 85x40.4x22	ENEC
700	13-21	14	LMTC15W700-Z	220-240	Triac	10-100	75	0.90	(D) 85x40.4x22	ENEC
500-1000	21-60	30	LTTC30WXXXLR LTTC30WXXXLR-Z	220-240	Triac ★	10-100	85	0.90	(E) 103x67x30.5 153x67x30.5	ENEC
500-1000	28-80	40	LTTC40WXXXLR LTTC40WXXXLR-Z	220-240	Triac ★	10-100	85	0.90	(E) 103x67x30.5 153x67x30.5	ENEC
350	21-28	9	LLTC10W350-Z	220-240	Triac	10-100	75	0.90	(F) 112.7.3x40x26.4	CE
500-1000	21-60	30	LBTC30WXXXLR LBTC30WXXXLR-Z	220-240	Triac ★	10-100	85	0.90	(G) 115x44x30 137.4x44x30	ENEC
300-700	18-60	20	LLTC20WXXXLR-Z	220-240	Triac ★	10-100	80	0.90	(H) 167x38.4x29.8	ENEC

★ CubePower G3 dimming series - O/P current can be slected before shipment

* In applying



PSE Dimmable LED Driver

The best fit for Japan commercial sites





The best fit for Japan commercial sites

Dimmable LED drivers featured with HEP advanced innovation of dimming technology, including Triac and PWM, enable versatile LED applications. The newly invented LED drivers operate dimming inputs on phase-cutting (Triac) or PWM with no conflict.

Simple choice by actual lighting needs brings maximum convenience and ultra control flexibility to job sites.

With special 'nippon-styling' case & connection design, the driver simply blends into the luminaires itself rather than draws attention over the architecture.

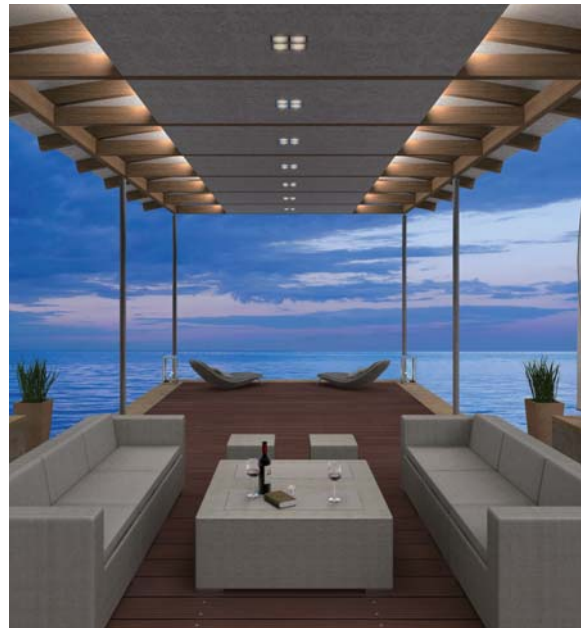

Dimming/control modes

Triac Dimming



Triac Dimmer
Input Voltage 100-120V



PWM

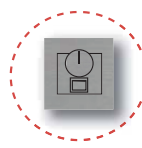



PWM Dimmer
Input Voltage 100-242V



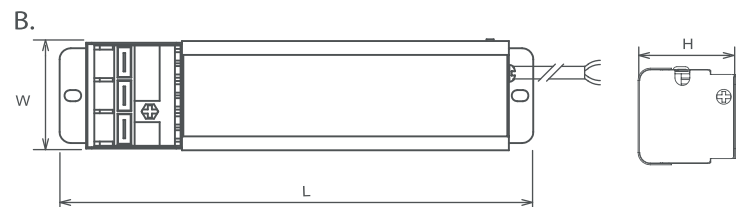
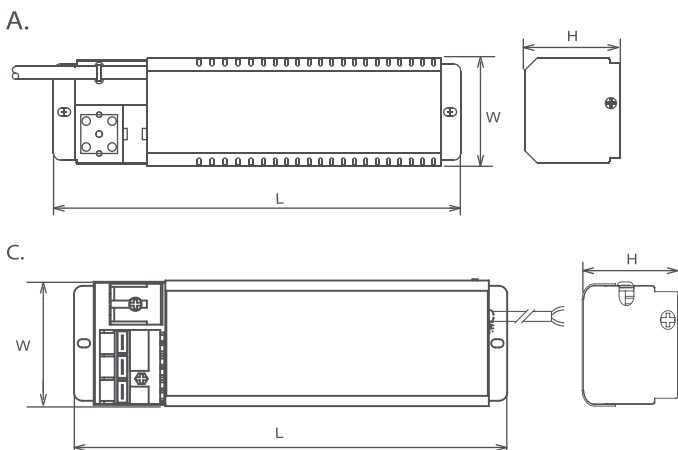







Dimension











Non-dim

Output Current (mA)	Output Voltage (V)	Watts (W)	Model	Input Voltage (V)	Efficiency (%)	Power Factor	Dimension LxWxH (mm)	Approbations
480	30-44	21	LJKCC21W480	100-242	83	0.9	(B)170x39.2x39.5	
900	30-44	40	LJLCC40W900	100-242	85	0.9	(B)180x42.6x42.5	

Triac Dimming

Output Current (mA)	Output Voltage (V)	Watts (W)	Model	Input Voltage (V)	Dimming Type	Dimming Range (%)	Efficiency (%)	Power Factor	Dimension LxWxH (mm)	Approbations
350	24-43	15	LJKTC15W350	100-120	TRIAC	3-100	80	0.9	(B)170x39.2x39.5	
480	8-31.5	15	LJKTC15W480	100-120	TRIAC	3-100	80	0.9	(B)170x39.2x39.5	
500	18-30	15	LJKTC15W500	100-120	TRIAC	3-100	80	0.9	(B)170x39.2x39.5	
700	8-21.5	15	LJKTC15W700	100-120	TRIAC	3-100	80	0.9	(B)170x39.2x39.5	
480	30-44	21	LJKTC21W480	100-120	TRIAC	3-100	83	0.9	(B)170x39.2x39.5	
700	20-50	35	LJLTC35W700	100-120	TRIAC	3-100	83	0.9	(B)180x42.6x42.5	
1000	20-35	35	LJLTC35W1000	100-120	TRIAC	3-100	83	0.9	(B)180x42.6x42.5	
900	30-44	40	LJLTC40W900	100-120	TRIAC	3-100	83	0.9	(B)180x42.6x42.5	
700	40-80	56	LJCTC56W700	100-120	TRIAC	10-100	80	0.85	(A)205.8x49x40.5	

PWM Dimming

Output Current (mA)	Output Voltage (V)	Watts (W)	Model	Input Voltage (V)	Dimming Type	Dimming Range (%)	Efficiency (%)	Power Factor	Dimension LxWxH (mm)	Approbations
350	18-29	10	LJMPC10W350	100-242	PWM	3-100	75	0.9	(C)142.4x61x42.5	
700	8-21.5	10	LJMPC10W700	100-242	PWM	3-100	75	0.9	(C)142.4x61x42.5	
700	15-26	15	LJMPC15W700	100-242	PWM	3-100	80	0.9	(C)142.4x61x42.5	
500	30-42	21	LJMPC21W500	100-242	PWM	3-100	82	0.9	(C)142.4x61x42.5	
900	17-25	21	LJMPC21W900	100-242	PWM	3-100	82	0.9	(C)142.4x61x42.5	
800	32-44	35	LJMPC35W800	100-242	PWM	3-100	83	0.9	(C)142.4x61x42.5	
480	8-31.5	15	LJNPC15W480(HP)	100-242	PWM	1-100	80	0.9	(C)149.4x61x42.5	
700	8-21.5	15	LJNPC15W700(HP)	100-242	PWM	1-100	80	0.9	(C)149.4x61x42.5	
700	20-50	35	LJNPC35W700(HP)	100-242	PWM	1-100	83	0.9	(C)169.4x61x42.5	

* HP : HOT SWAP

Electronic Transformer

Output Current (mA)	Output Voltage (V)	Watts (W)	Model	Input Voltage (V)	Dimming Type	Dimming Range (%)	Efficiency (%)	Power Factor	Dimension LxWxH (mm)	Approbations
6500	10-11	20-75	TJA75	100-120	TRIAC	10-100	91	0.85	(A)168x40x36.5	

★ Load is 20-75W

★ Dim for Halogen lamp or MR16 LED by using approved dimmer



Mini-type LED Driver

Small enough for versatile LED applications





Small enough for versatile LED applications

Features

- Small form offers factory design more flexibility
- Wide input voltage 100-277V , 50-60Hz meets all demand
- Potting model for indoor and outdoor use can match all application needs
-    

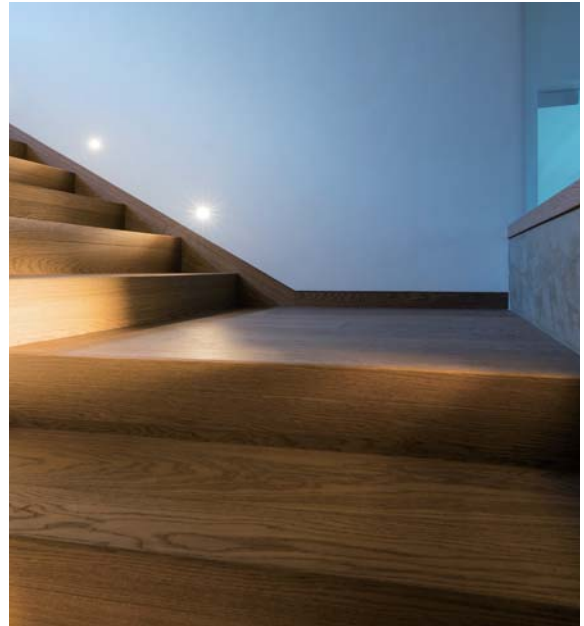

Dimension

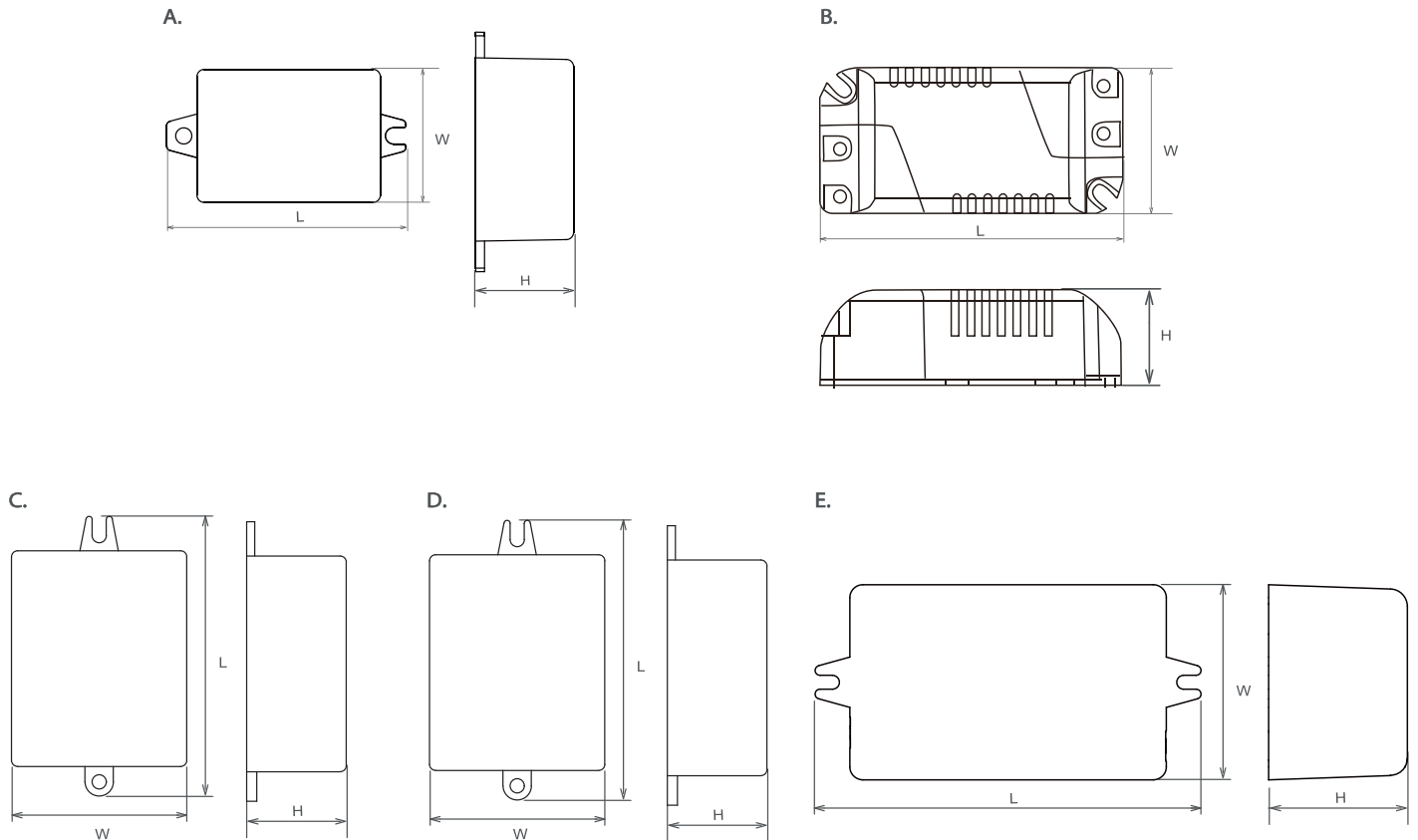

Applicable fixture : Down light, wall light, spot light, track light, decoration light



Application site : indoor - office lighting, restaurant, shopping mall, meeting room
 outdoor - wall lamp, garden light, ground light

Output Current (mA)	Output Voltage (V)	Watts (W)	Model	Input Voltage (V)	Efficiency (%)	Power Factor	Dimension LxWxH(mm)	Approbations
170	24	4	* LSV4W24HSP UNI	100-277	70	0.40	(A)49x27.2x20	cRU
250	16	4	* LSV4W16HSP UNI	100-277	70	0.40	(A)49x27.2x20	cRU
330	12	4	* LSV4W12HSP UNI	100-277	70	0.40	(A)49x27.2x20	cRU
330	12	4	* LSV4W12(P) UNI	100-277	70	0.40	(A)49x27.2x20	cRU
200	13.5-16.3	3	LSC4W200P UNI	100-277	65	0.40	(A)49x27.2x20	ENEC*
350	8-13	4	LSC4W350(P) UNI	100-277	65	0.40	(A)49x27.2x20	ENEC, cRU
500	5.5-9.5	4	LSC4W500(P) UNI	100-277	65	0.40	(A)49x27.2x20	ENEC, cRU
700	2.8-6.5	4	LSC4W700(P) UNI	100-277	65	0.40	(A)49x27.2x20	ENEC, cRU
350	3-8	1-2.8	LSC4W350L-Z UNI	100-277	65	0.40	(B)68x33x22	ENEC*
350	8-13	2.8-4.6	LSC4W350H-Z UNI	100-277	65	0.40	(B)68x33x22	ENEC*
500	2.8-7	1.4-3.5	LSC4W500-Z UNI	100-277	65	0.40	(B)68x33x22	ENEC*
700	2.8-7	2-4.9	LSC4W700-Z UNI	100-277	65	0.40	(B)68x33x22	ENEC*
300	14-27.5	8	LSC9W300(P) UNI	100-277	80	0.90	(C)60x40x24	cRU
350	9-24	8	LSC9W350(P) UNI	100-277	80	0.90	(C)60x40x24	ENEC, cRU
500	6.5-18	9	LSC9W500(P) UNI	100-277	80	0.90	(C)60x40x24	ENEC, cRU
700	6-12	8	LSC9W700(P) UNI	100-277	80	0.90	(C)60x40x24	ENEC, cRU
250	32-55	13	LSC15W250P UNI	100-277	80	0.90	(D)63.3x40x23	ENEC*
350	23-43	15	LSC15W350P UNI	100-277	80	0.90	(D)63.3x40x23	ENEC*
500	18-30	15	LSC15W500P UNI	100-277	80	0.90	(D)63.3x40x23	ENEC*
700	12-22	15	LSC15W700P UNI	100-277	80	0.90	(D)63.3x40x23	ENEC*
250	32-55	13	LSC20W250(P) UNI	100-277	84	0.80	(D)69.1x43.3x24.6	ENEC, cRU
300	32-55	16.5	LSC20W300(P) UNI	100-277	84	0.90	(D)69.1x43.3x24.6	ENEC, cRU
350	32-55	19	LSC20W350(P) UNI	100-277	84	0.90	(D)69.1x43.3x24.6	ENEC, cRU
500	12-28	14	LSC20W500L(P) UNI	100-277	84	0.85	(D)69.1x43.3x24.6	ENEC, cRU
500	24-45	22	LSC20W500HP UNI	100-277	84	0.90	(D)69.1x43.3x24.6	ENEC, cRU
700	11-28	19	LSC20W700(P) UNI	100-277	84	0.90	(D)69.1x43.3x24.6	ENEC, cRU
450	36-52.5	23	LCD36W450C UNI	100-277	85	0.90	(E)89x45x32	ENEC
500	36-52.5	26	* LCD36W500(-1C) UNI	120-240/120	85	0.90	(E)89x45x32	ENEC, cRU
600	36-52.5	31	* LCD36W600(-1C) UNI	120-240/120	85	0.90	(E)89x45x32	ENEC, cRU
700	36-52.5	36	* LCD36W700(-1C) UNI	120-240/120	85	0.90	(E)89x45x32	ENEC, cRU
700	30-52.5	36	LCD36W700C UNI	100-240	85	0.90	(E)89x45x32	ENEC
800	26-38	30	* LCD36W800(-1C) UNI	120-240/120	85	0.90	(E)89x45x32	ENEC, cRU
850	27-42	35	LCD36W850C UNI	120-240	85	0.90	(E)89x45x32	ENEC
900	24-34	30	* LCD36W900(-1C) UNI	120-240/120	85	0.90	(E)89x45x32	ENEC, cRU
900	27-42	37	LCD36W900C UNI	120-240	85	0.90	(E)89x45x32	ENEC
925	27-40	37	LCD36W925C UNI	120-240	85	0.90	(E)89x45x32	ENEC
1050	24-29	30	* LCD36W1050(-1C) UNI	120-240/120	85	0.90	(E)89x45x32	ENEC, cRU

*CV LED Driver

*0/1-10V dimming or non-dim



EVO LED Driver

Evolution Low-Ripple Drivers In Design for High CP service





Evolution Low-Ripple Drivers In Design for High CP service

Features

- Compact design for economical selection
- Comprehensive current range in 350-1050mA
- High efficiency >88%
- Low ripple current $\pm 7\%$
- Life time 30,000 hrs
- **TUV SAA CE RoHS**



Dimension

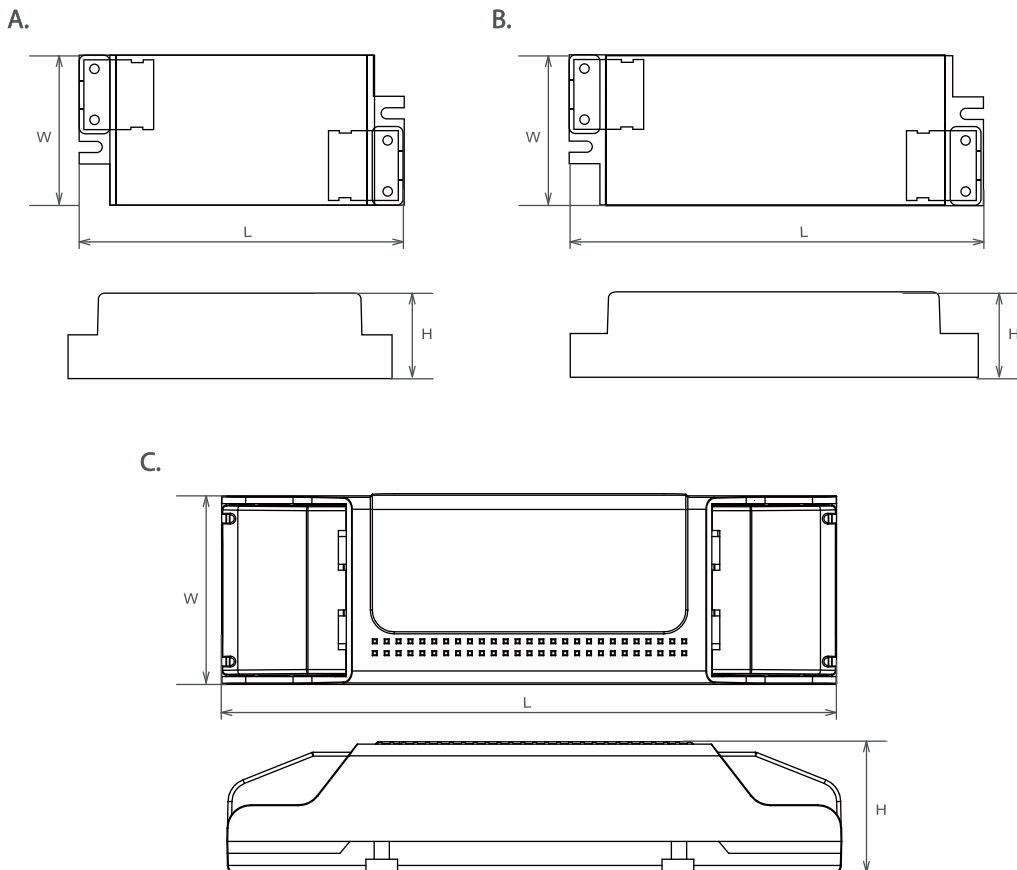



Output Current (mA)	Output Voltage (V)	Watts (W)	Model	Input Voltage (V)	Efficiency (%)	Power Factor	Dimension LxWxH(mm)	Approbations
350	36-52	18	EVO18W350LR-Z	220-240	88	0.92	(A)88.5x41.3x23	TUV, SAA
450	30-40	18	EVO18W450LR-Z	220-240	88	0.92	(A)88.5x41.3x23	TUV, SAA
450	33-49	22	EVO21W450LR-Z	220-240	88	0.92	(A)88.5x41.3x23	TUV, SAA
500	22-36	18	EVO18W500LR-Z	220-240	88	0.92	(A)88.5x41.3x23	TUV, SAA
500	30-42	21	EVO21W500LR-Z	220-240	88	0.92	(A)88.5x41.3x23	TUV, SAA
550	22-33	18	EVO18W550LR-Z	220-240	88	0.92	(A)88.5x41.3x23	TUV, SAA
550	30-40	22	EVO21W550LR-Z	220-240	88	0.92	(A)88.5x41.3x23	TUV, SAA
600	19-30	18	EVO18W600LR-Z	220-240	88	0.92	(A)88.5x41.3x23	TUV, SAA
600	25-35	21	EVO21W600LR-Z	220-240	88	0.92	(A)88.5x41.3x23	TUV, SAA
700	17-26	18	EVO18W700LR-Z	220-240	88	0.92	(A)88.5x41.3x23	TUV, SAA
700	22-30	21	EVO21W700LR-Z	220-240	88	0.92	(A)88.5x41.3x23	TUV, SAA
500	33-47	23	EVO24W500LR-Z	220-240	88	0.95	(B)117x42.5x24	TUV, SAA
550	30-44	24	EVO24W550LR-Z	220-240	88	0.95	(B)117x42.5x24	TUV, SAA
600	30-40	24	EVO24W600LR-Z	220-240	88	0.95	(B)117x42.5x24	TUV, SAA
600	36-50	30	EVO30W600LR-Z	220-240	89	0.95	(B)117x42.5x24	TUV, SAA
700	25-35	24	EVO24W700LR-Z	220-240	88	0.95	(B)117x42.5x24	TUV, SAA
700	30-43	30	EVO30W700LR-Z	220-240	89	0.95	(B)117x42.5x24	TUV, SAA
700	36-51	35	EVO36W700LR-Z	220-240	89	0.95	(B)117x42.5x24	TUV, SAA
800	30-45	36	EVO36W800LR-Z	220-240	89	0.95	(B)117x42.5x24	TUV, SAA
850	30-42	35	EVO36W850LR-Z	220-240	89	0.95	(B)117x42.5x24	TUV, SAA
900	30-40	36	EVO36W900LR-Z	220-240	89	0.95	(B)117x42.5x24	TUV, SAA
900	33-46	41	EVO42W900LR-Z	220-240	89	0.95	(B)117x42.5x24	TUV, SAA
950	30-44	41	EVO42W950LR-Z	220-240	89	0.95	(B)117x42.5x24	TUV, SAA
1000	30-42	42	EVO42W1000LR-Z	220-240	89	0.95	(B)117x42.5x24	TUV, SAA
1050	25-35	36	EVO36W1050LR-Z	220-240	89	0.95	(B)117x42.5x24	TUV, SAA
1050	30-40	42	EVO42W1050LR-Z	220-240	89	0.95	(B)117x42.5x24	TUV, SAA
1200	30-40	50	EVO50W1200LR-Z	220-240	90	0.95	(C)155x47.5x33.1	* ENEC, SAA
1400	25-36	50	EVO50W1400LR-Z	220-240	90	0.95	(C)155x47.5x33.1	* ENEC, SAA
1050	36-52	54.6	EVO60W1050LR-Z	220-240	90	0.95	(C)155x47.5x33.1	* ENEC, SAA
1200	36-50	60	EVO60W1200LR-Z	220-240	90	0.95	(C)155x47.5x33.1	* ENEC, SAA
1300	33-46	59.8	EVO60W1300LR-Z	220-240	90	0.95	(C)155x47.5x33.1	* ENEC, SAA
1400	30-42	58.8	EVO60W1400LR-Z	220-240	90	0.95	(C)155x47.5x33.1	* ENEC, SAA

* In applying

■ **Constant Current** LED drivers chart (sorting by wattage)

Model Art.-Nr	Input voltage Nennspannung (VAC)	Output Ausgang			Power Factor	Efficiency (%)	Approbations Kenn-prüfzeichen	Dimension Dimension L x W x H (mm)
		Wattage Wattagen (W)	Current Ausgangsstrom (mA)	Voltage Spannung (VDC)				
LSVC3A UNI	100-240	1-3	350	3-9	0.4	60	ENEC	48.9 x 39.1 x 20
	100-240	1-3	350	3-9	0.4	60	cRU	48.9 x 39.1 x 20
LSVC3B UNI	100-240	3	700	4-5	0.4	60	ENEC	48.9 x 39.1 x 20
	100-120	3	700	4-5	0.4	60	cRU	48.9 x 39.1 x 20
LSVC3A-Z UNI	100-240	1-3	350	3-9	0.4	60	ENEC	55.8 x 39 x 20
LSVC3B-Z UNI	100-240	3	700	4-5	0.4	60	ENEC	55.8 x 39 x 20
LSVC3BZ UNI	100-240	2.4	560	4-5	0.4	60	cRU	55.8 x 39 x 20
LSVC3AI-Z UNI	100-240	1-3	350	3-9	0.4	60	ENEC	55.8 x 39 x 20
LSVC3AIZ UNI	100-240	1-3	300	3-9	0.4	60	cRU	55.8 x 39 x 20
LSVC3BI-Z UNI	100-240	3	700	4-5	0.4	60	ENEC	55.8 x 39 x 20
LSVC3BIZ UNI	100-240	2.4	560	4-5	0.4	60	cRU	55.8 x 39 x 20
LSVC3AP UNI	100-240	1-3	350	3-9	0.4	60	ENEC	47.4 x 37.7 x 20
	100-120	1-3	350	3-9	0.4	60	cRU	47.4 x 37.7 x 20
LSVC3BP UNI	100-120	3	700	4-5	0.4	60	cRU	47.4 x 37.7 x 20
	100-240	3	700	4-5	0.4	60	CE	47.4 x 37.7 x 20
LRVC3A UNI	100-120	1-3	350	3-9	0.4	60	cRU	43 x 20
	100-240	1-3	350	3-9	0.4	60	ENEC	43 x 20
LRVC3B UNI	100-240	3	700	4-5	0.4	60	ENEC	43 x 20
LIVC4A UNI	100-240	1-3.8	350	3-10.8	0.4	55	ENEC	58.1 x 39.1 x 20
LIVC4B UNI	100-240	3.5	700	4-5	0.4	45	ENEC	58.1 x 39.1 x 20
LIVC4A-Z UNI	100-240	1-3.8	350	3-10.8	0.4	55	ENEC	65 x 39 x 20
LIVC4B-Z UNI	100-240	3.5	700	4-5	0.4	45	ENEC	65 x 39 x 20
LIVC4AI-Z UNI	100-240	1-3.8	350	3-10.8	0.4	55	ENEC	65 x 39 x 20
LIVC4BI-Z UNI	100-240	3.5	700	4-5	0.4	45	ENEC	65 x 39 x 20
LFVC4A-Z UNI	100-240	1-4.9	350	3-14	0.45	73	ENEC	72.8 x 40 x 16
LFVC4B-Z UNI	100-240	3-4.9	700	4-7	0.45	54	ENEC	72.8 x 40 x 16
LFVC4BI-Z UNI	100-240	3-4.9	700	4-7	0.45	54	ENEC	72.8 x 40 x 16
LSC4W250P UNI	100-277	3	250	13.5-16.3	0.40	65	ENEC (In applying)	49 x 27.2 x 20
LSC4W350(P) UNI	100-277	2.8-4.55	350	8-13	0.40	65	ENEC/cRU	49 x 27.2 x 20
LSC4W500(P) UNI	100-277	2.75-4.75	500	5.5-9.5	0.40	65	ENEC/cRU	49 x 27.2 x 20
LSC4W700(P) UNI	100-277	1.96-4.55	700	2.8-6.5	0.40	65	ENEC/cRU	49 x 27.2 x 20
LSC4W350H-Z UNI	100-277	2.8-4.55	350	8-13	0.40	65	CE	68 x 33 x 22
LSC4W350L-Z UNI	100-277	1-2.8	350	3-8	0.40	65	CE	68 x 33 x 22

■ **Constant Current LED drivers chart (sorting by wattage)**

Model Art. -Nr	Input voltage Nenn- spannung (VAC)	Output Ausgang			Power Factor	Efficiency (%)	Approbations Kenn-prüfzeichen	Dimension Dimension L x W x H (mm)
		Wattage Wattagen (W)	Current Ausgangsstrom (mA)	Voltage Spannung (VDC)				
LSC4W500-Z UNI	100-277	2.75-4.75	500	5.5-9.5	0.40	65	CE	68 x 33 x 22
LSC4W700-Z UNI	100-277	1.96-4.55	700	2.8-6.5	0.40	65	CE	68 x 33 x 22
LSC6W320C UNI	100-240	3-6	320	9.4-18.8	0.90	78	ENEC	55.5 x 38.5 x 22
LSC6W320(I)-Z UNI	100-240	3-6	320	9.4-18.8	0.90	78	ENEC	66.3 x 38.5 x 22
LSC6W350C UNI	100-240	3-6.3	350	8.6-18	0.90	78	ENEC	55.5 x 38.5 x 20
LSC6W350(I)-Z UNI	100-240	3-6.3	350	8.6-18	0.90	78	ENEC	66.3 x 38.5 x 22
LSC6W500C UNI	100-240	3-6	500	6-12	0.90	78	ENEC	55.5 x 38.5 x 20
LSC6W500(I)-Z UNI	100-240	3-6	500	6-12	0.90	78	ENEC	66.3 x 38.5 x 22
LSC6W700C UNI	100-240	3-6.3	700	4.3-9	0.90	78	ENEC	55.5 x 38.5 x 20
LSC6W700(I)-Z UNI	100-240	3-6.3	700	4.3-9	0.90	78	ENEC	66.3 x 38.5 x 22
LMVC8A UNI	100-240	1-9	350	3-26	0.40	80	ENEC	85 x 40.4 x 22
	100-240	1-8	350	3-24	0.40	80	RU	85 x 40.4 x 22
LMVC8AI UNI	100-240	1-9	350	3-26	0.40	80	ENEC	85 x 40.4 x 22
	100-240	1-8	350	3-24	0.40	80	RU	85 x 40.4 x 22
LSC9W300R(P) UNI	100-277	4.2-8.3	300	14-27.5	0.90	80	cRU	∅55 x 22
LSC9W350R(P) UNI	100-277	3.2-8.4	350	9-24	0.90	80	cRU	∅55 x 22
LSC9W500R(P) UNI	100-277	3.25-9	500	6.5-18	0.90	80	cRU	∅55 x 22
LSC9W700R(P) UNI	100-277	4.2-8.4	700	6-12	0.90	80	cRU	∅55 x 22
LSC9W300(P) UNI	100-277	4.2-8.3	300	14-27.5	0.90	80	cRU	60x40x24
LSC9W350(P) UNI	100-277	3.2-8.4	350	9-24	0.90	80	ENEC/cRU	60x40x24
LSC9W500(P) UNI	100-277	3.25-9	500	6.5-18	0.90	80	ENEC/cRU	60x40x24
LSC9W700(P) UNI	100-277	4.2-8.4	700	6-12	0.90	80	ENEC/cRU	60x40x24
LIC9W200 UNI	100-240	6-9	200	30-45	0.90	80	ENEC	58.1 x 39 x 20
LIC9W200(I)-Z UNI	100-240	6-9	200	30-45	0.90	80	ENEC	65 x 39 x 20
LIC9W300 UNI	100-240	6-9	300	20-30	0.90	80	ENEC	58.1 x 39 x 20
LIC9W300(I)-Z UNI	100-240	6-9	300	20-30	0.90	80	ENEC	65 x 39 x 20
LIC9W350 UNI	100-240	6-9	350	17.1-25.7	0.90	80	ENEC	58.1 x 39 x 20
LIC9W350(I)-Z UNI	100-240	6-9	350	17.1-25.7	0.90	80	ENEC	65 x 39 x 20
LIC9W450 UNI	100-240	6-9	450	13.3-20	0.90	80	ENEC	58.1 x 39 x 20
LIC9W450(I)-Z UNI	100-240	6-9	450	13.3-20	0.90	80	ENEC	65 x 39 x 20
LIC9W500 UNI	100-240	6-9	500	12-18	0.90	80	ENEC	58.1 x 39 x 20
LIC9W500(I)-Z UNI	100-240	6-9	500	12-18	0.90	80	ENEC	65 x 39 x 20
LIC9W600 UNI	100-240	6-9	600	10-15	0.90	80	ENEC	58.1 x 39 x 20

■ **Constant Current LED drivers chart (sorting by wattage)**

Model Art. -Nr	Input voltage Nennspannung (VAC)	Output Ausgang			Power Factor	Efficiency (%)	Approbations Kenn-prüfzeichen	Dimension Dimension L x W x H (mm)
		Wattage Wattagen (W)	Current Ausgangsstrom (mA)	Voltage Spannung (VDC)				
LIC9W600(I)-Z UNI	100-240	6-9	600	10-15	0.90	80	ENEC	65 x 39 x 20
LIC9W700 UNI	100-240	6-9	700	8.6-12.9	0.90	80	ENEC	58.1 x 39 x 20
LIC9W700(I)-Z UNI	100-240	6-9	700	8.6-12.9	0.90	80	ENEC	65 x 39 x 20
LRC9W200(P) UNI	100-240	6-8.1	200	30-40.5	0.90	80	ENEC	55 x 22
LRC9W350(P) UNI	100-240	5.6-9.1	350	16-26	0.90	80	ENEC	55 x 22
LRC9W450(P)UNI	100-240	6-9	450	13-20	0.90	80	ENEC	55 x 22
LRC9W500(P)UNI	100-240	6-9	500	12-18	0.90	80	ENEC	55 x 22
LRC9W600(P)UNI	100-240	6-8.1	600	10-13.5	0.90	80	ENEC	55 x 22
LRC9W700(P)UNI	100-240	5-8.9	700	7.2-12.8	0.90	80	ENEC	55 x 22
LMC10W200-Z	220-240	5.8-8.8	200	29-44	0.90	75	ENEC	85 x 40.4 x 22
LMC10W250-Z	220-240	6.5-10	250	26-40	0.90	75	ENEC	85 x 40.4 x 22
LMC10W350-Z	220-240	5.95-10.15	350	17-29	0.90	75	ENEC	85 x 40.4 x 22
LMC10W450-Z	220-240	5.4-9	450	12-20	0.90	75	ENEC	85 x 40.4 x 22
LMC10W500-Z	220-240	6-10	500	12-20	0.90	75	ENEC	85 x 40.4 x 22
LMC10W600-Z	220-240	5.1-8.7	600	8.5-14.5	0.90	75	ENEC	85 x 40.4 x 22
LMC10W700-Z	220-240	5.95-10.15	700	8.5-14.5	0.90	75	ENEC	85 x 40.4 x 22
LMC15W300-Z	220-240	7.8-12.9	300	26-43	0.90	80	ENEC	85 x 40.4 x 22
LMC15W350-Z	220-240	9.1-15	350	26-43	0.90	80	ENEC	85 x 40.4 x 22
LMC15W450-Z	220-240	8.1-13.5	450	18-30	0.90	80	ENEC	85 x 40.4 x 22
LMC15W500-Z	220-240	9-15	500	18-30	0.90	80	ENEC	85 x 40.4 x 22
LMC15W600-Z	220-240	7.8-12.6	600	13-21	0.90	80	ENEC	85 x 40.4 x 22
LMC15W700-Z	220-240	9.1-14.7	700	13-21	0.90	80	ENEC	85 x 40.4 x 22
LSC15W350P UNI	100-277	8-15	350	23-43	0.90	80	CE	63.3 x 40 x 23
LSC15W500P UNI	100-277	9-15	500	18-30	0.90	80	CE	63.3 x 40 x 23
LSC15W700P UNI	100-277	8.4-15	700	12-22	0.90	80	CE	63.3 x 40 x 23
EVO18W350LR-Z	220-240	12.6-18.2	350	36-52	0.92	88	TUV,SAA	88.5 x 41.3 x 23
EVO18W450LR-Z	220-240	13.5-18	450	30-40	0.92	88	TUV,SAA	88.5 x 41.3 x 23
EVO18W500LR-Z	220-240	11-18	500	22-36	0.92	88	TUV,SAA	88.5 x 41.3 x 23
EVO18W550LR-Z	220-240	12.1-18.2	550	22-33	0.92	88	TUV,SAA	88.5 x 41.3 x 23
EVO18W600LR-Z	220-240	11.4-18	600	19-30	0.92	88	TUV,SAA	88.5 x 41.3 x 23
EVO18W700LR-Z	220-240	11.9-18.2	600	17-26	0.92	88	TUV,SAA	88.5 x 41.3 x 23
G2+20W500CA	220-240	7.5-10.5	250	30-42	0.90	83	ENEC	97 x 43 x 30 147 x 43 x 30

■ **Constant Current LED drivers chart (sorting by wattage)**

Model Art.-Nr	Input voltage Nennspannung (VAC)	Output Ausgang			Power Factor	Efficiency (%)	Approbations Kennprüfzeichen	Dimension Dimension L x W x H (mm)
		Wattage Wattagen (W)	Current Ausgangsstrom (mA)	Voltage Spannung (VDC)				
G2+20W500CA	220-240	10.5-14.5	350	30-42	0.90	83	ENEC	97 x 43 x 30 147 x 43 x 30
G2+20W500CA	220-240	15-21	500	30-42	0.90	83	ENEC	97 x 43 x 30 147 x 43 x 30
LNCC20WXXLR-Z	220-240	8.5-22.4	250-800	18-57	0.90	84	ENEC	111 x 40 x 26.5
LBC20W300 UNI	120-277	10.8-16.7	300	36-55.7	0.90	80	cRU	94 x 44 x 30
LBC20W350(-Z) UNI	120-277	12.6-19.5	350	36-55.7	0.90	80	ENEC/cRU	94 x 44 x 30 116.4 x 44 x 30
LBC20W450(-Z) UNI	120-277	12.6-19.8	450	28-44	0.90	80	ENEC	94 x 44 x 30 116.4 x 44 x 30
LBC20W500(-Z) UNI	120-277	13-20	500	26-40	0.90	80	ENEC	94 x 44 x 30 116.4 x 44 x 30
LBC20W550(-Z) UNI	120-277	13.2-19.8	550	24-36	0.90	80	ENEC	94 x 44 x 30 116.4 x 44 x 30
LBC20W600(-Z) UNI	120-277	12.6-18	600	21-30	0.90	80	ENEC	94 x 44 x 30 116.4 x 44 x 30
LBC20W700(-Z) UNI	120-277	12.6-19.6	700	18-28	0.90	80	ENEC	94 x 44 x 30 116.4 x 44 x 30
LSC20W250(P) UNI	100-277	8-13.7	250	32-55	0.80	84	ENEC/cRU	69.3 x 43.5 x 24.6
LSC20W300(P) UNI	100-277	9.6-16.5	300	32-55	0.90	84	ENEC/cRU	69.3 x 43.5 x 24.6
LSC20W350(P) UNI	100-277	11-19.3	350	32-55	0.90	84	ENEC/cRU	69.3 x 43.5 x 24.6
LSC20W500L(P) UNI	100-277	6-14	500	12-28	0.85	84	ENEC/cRU	69.3 x 43.5 x 24.6
LSC20W500H UNI	100-277	12-22.5	500	24-45	0.90	84	cRU	69.3 x 43.5 x 24.6
LSC20W500HP UNI	100-277	12-22.5	500	24-45	0.90	84	ENEC/cRU	69.3 x 43.5 x 24.6
LSC20W700(P) UNI	100-277	7.7-19.6	700	11-28	0.90	84	ENEC/cRU	69.3 x 43.5 x 24.6
EVO21W450LR-Z	220-240	14.9-22	450	33-49	0.92	86	TUV,SAA	88.5 x 41.3 x 23
EVO21W500LR-Z	220-240	15-21	500	30-42	0.92	86	TUV,SAA	88.5 x 41.3 x 23
EVO21W550LR-Z	220-240	16.5-22	550	30-40	0.92	86	TUV,SAA	88.5 x 41.3 x 23
EVO21W600LR-Z	220-240	15-21	600	25-35	0.92	86	TUV,SAA	88.5 x 41.3 x 23
EVO21W700LR-Z	220-240	15.4-21	700	22-30	0.92	86	TUV,SAA	88.5 x 41.3 x 23
LJKCC21W480	100-242	21	480	30-44	0.90	83	PSE	170 x 39.2 x 39.5
LAC22W460 120V	120	16.56-21.16	460	36-46	0.95	87	CE	235 x 30 x 26
EVO24W500LR-Z	220-240	16.5-23.5	500	33-47	0.95	88	TUV,SAA	117 x 42.5 x 24
EVO24W550LR-Z	220-240	16.5-24.2	550	30-44	0.95	88	TUV,SAA	117 x 42.5 x 24
EVO24W600LR-Z	220-240	18-24	600	30-40	0.95	88	TUV,SAA	117 x 42.5 x 24
EVO24W700LR-Z	220-240	17.5-24.5	700	25-35	0.95	88	TUV,SAA	117 x 42.5 x 24
LEC25W500 UNI	100-240	16.5	500	26-33	0.90	80	CE	123 x 37 x 30
LEC25W540 UNI	100-240	17.8	540	26-33	0.90	80	CE	123 x 37 x 30
LEC25W600 UNI	100-240	19.8	600	26-33	0.90	80	CE	123 x 37 x 30
LEC25W700 UNI	100-240	21.7	700	25-31	0.90	80	CE	123 x 37 x 30

■ **Constant Current LED drivers chart (sorting by wattage)**

Model Art. -Nr	Input voltage Nenn- spannung (VAC)	Output Ausgang			Power Factor	Efficiency (%)	Approbations Kenn-prüfzeichen	Dimension Dimension L x W x H (mm)
		Wattage Wattagen (W)	Current Ausgangsstrom (mA)	Voltage Spannung (VDC)				
LEC25W720 UNI	100-240	22.3	720	25-31	0.90	80	CE	123 x 37 x 30
LEC25W840 UNI	100-240	24.3	840	23-29	0.90	80	CE	123 x 37 x 30
LEC25W900 UNI	100-240	23.4	900	21-26	0.90	80	CE	123 x 37 x 30
LEC25W1000 UNI	100-240	25	1000	20-25	0.90	80	CE	123 x 37 x 30
LEC25W1100 UNI	100-240	24.2	1100	18-22	0.90	80	CE	123 x 37 x 30
LEC25W1200 UNI	100-240	24	1200	16-20	0.90	80	CE	123 x 37 x 30
LCC30W500	220-240	17.5-22.5	500	35-45	0.90	82	ENEC	79.8 x 78.1 x 25.4
LCC30W700	220-240	19.6-26.6	700	28-38	0.90	82	ENEC	79.8 x 78.1 x 25.4
LCC30W900	220-240	21.6-30.6	900	24-34	0.90	82	ENEC	79.8 x 78.1 x 25.4
LCC30W1000	220-240	24-32	1000	24-32	0.90	82	ENEC	79.8 x 78.1 x 25.4
LCC30W1200	220-240	24-31.2	1200	20-26	0.90	82	ENEC	79.8 x 78.1 x 25.4
LCC30W1400	220-240	25.2-33.6	1400	18-24	0.90	82	ENEC	79.8 x 78.1 x 25.4
LBCC30WXXXLR(-Z)	220-240	21-30	500-1000	21-60	0.90	85	ENEC	115 x 44 x 30 137.4 x 44 x 30
LTCC30WXXXLR(-Z)	220-240	21-30	500-1000	21-60	0.90	85	ENEC	103 x 67 x 30.5 153 x 67 x 30.5
LTCP2130W2030(-Z) UNI	100-277	21-30	700-1500	20-30	0.90	80	ENEC	67 x 103 x 30.5 67 x 153 x 30.5
LTCP2130W3042(-Z) UNI	100-277	21-30	490-1000	30-42.86	0.90	80	ENEC	67 x 103 x 30.5 67 x 153 x 30.5
LTCP2130W4260(-Z) UNI	100-277	21-30	350-700	42.86-60	0.90	80	ENEC	67 x 103 x 30.5 67 x 153 x 30.5
EVO30W600LR-Z	220-240	21.6-30	600	36-50	0.95	89	TUV,SAA	117 x 42.5 x 24
EVO30W700LR-Z	220-240	21-30.1	700	33-43	0.95	89	TUV,SAA	117 x 42.5 x 24
G2 ⁺ 30W700CA	220-240	15-21	500	30-42	0.90	85	ENEC	97 x 43 x 30 147 x 43 x 30
G2 ⁺ 30W700CA	220-240	18-25	600	30-42	0.90	85	ENEC	97 x 43 x 30 147 x 43 x 30
G2 ⁺ 30W700CA	220-240	21-29.5	700	30-42	0.90	85	ENEC	97 x 43 x 30 147 x 43 x 30
LCD36W500 UNI	120-240	18-26.25	500	36-52.5	0.90	85	ENEC	73 x 45 x 32 89 x 45 x 32
LCD36W600 UNI	120-240	21.6-31.5	600	36-52.5	0.90	85	ENEC	73 x 45 x 32 89 x 45 x 32
LCD36W700 UNI	120-240	25.2-36.75	700	36-52.5	0.90	85	ENEC	73 x 45 x 32 89 x 45 x 32
LCD36W800 UNI	120-240	20.8-30.4	800	26-38	0.90	85	ENEC	73 x 45 x 32 89 x 45 x 32
LCD36W900 UNI	120-240	21.6-30.6	900	24-34	0.90	85	ENEC	73 x 45 x 32 89 x 45 x 32
EVO36W700LR-Z	220-240	25.2-35.7	700	36-51	0.95	89	TUV,SAA	117 x 42.5 x 24
EVO36W800LR-Z	220-240	24-36	800	30-45	0.95	89	TUV,SAA	117 x 42.5 x 24
EVO36W850LR-Z	220-240	25.5-35.7	850	30-42	0.95	89	TUV,SAA	117 x 42.5 x 24
EVO36W900LR-Z	220-240	27-36	900	30-40	0.95	89	TUV,SAA	117 x 42.5 x 24
EVO36W1050LR-Z	220-240	26.3-36.7	1050	25-35	0.95	89	TUV,SAA	117 x 42.5 x 24

■ **Constant Current LED drivers chart (sorting by wattage)**

Model Art. -Nr	Input voltage Nennspannung (VAC)	Output Ausgang			Power Factor	Efficiency (%)	Approbations Kenn-prüfzeichen	Dimension Dimension L x W x H (mm)
		Wattage Wattagen (W)	Current Ausgangsstrom (mA)	Voltage Spannung (VDC)				
LCD36W450C UNI	120-240	36-52.5	450	16.2-23.6	0.90	85	ENEC	73 x 45 x 32 89 x 45 x 32
LCD36W700C UNI	120-240	30-52.5	700	21-36.75	0.90	85	ENEC	73 x 45 x 32 89 x 45 x 32
LCD36W850C UNI	120-240	27-42	850	23-35.7	0.90	85	ENEC	73 x 45 x 32 89 x 45 x 32
LCD36W900C UNI	120-240	24.3-37.8	900	27-42	0.90	85	ENEC	73 x 45 x 32 89 x 45 x 32
LCD36W925C UNI	120-240	27-40	925	24.98-37	0.90	85	ENEC	73 x 45 x 32 89 x 45 x 32
LCD36W1050 UNI	120-240	25.2-30.45	1050	24-29	0.90	85	ENEC	73 x 45 x 32 89 x 45 x 32
LCD36W500 120V	120	26.25 max.	500	36-52.5	0.90	85	cRU	73 x 45 x 32 89 x 45 x 32
LCD36W600 120V	120	31.5 max.	600	36-52.5	0.90	85	cRU	73 x 45 x 32 89 x 45 x 32
LCD36W700 120V	120	36.75 max.	700	36-52.5	0.90	85	cRU	73 x 45 x 32 89 x 45 x 32
LCD36W800 120V	120	30.4 max.	800	26-38	0.90	85	cRU	73 x 45 x 32 89 x 45 x 32
LCD36W900 120V	120	30.6 max.	900	24-34	0.90	85	cRU	73 x 45 x 32 89 x 45 x 32
LCD36W1050 120V	120	30.45 max.	1050	24-29	0.90	85	cRU	73 x 45 x 32 89 x 45 x 32
G2+38W900CA	220-240	21-29.5	700	30-42	0.90	85	ENEC	97 x 43 x 30 147 x 43 x 30
G2+38W900CA	220-240	24-33.5	800	30-42	0.90	85	ENEC	97 x 43 x 30 147 x 43 x 30
G2+38W900CA	220-240	27-38	900	30-42	0.90	85	ENEC	97 x 43 x 30 147 x 43 x 30
LLC40W500(-Z) UNI	100-240	14.5-29	500	29-58	0.90	87-91	ENEC	144 x 46x 30 166.5 x 46 x 30
LLC40W600(-Z) UNI	100-240	17.5-35	600	29-58	0.90	87-91	ENEC	144 x 46x 30 166.5 x 46 x 30
LLC40W700(-Z) UNI	100-240	20-40	700	29-58	0.90	87-91	ENEC	144 x 46x 30 166.5 x 46 x 30
LLC40W800(-Z) UNI	100-240	20-40	800	25-50	0.90	87-91	ENEC	144 x 46x 30 166.5 x 46 x 30
LLC40W900(-Z) UNI	100-240	20-40	900	22-44	0.90	87-91	ENEC	144 x 46x 30 166.5 x 46 x 30
LLC40W1000(-Z) UNI	100-240	20-40	1000	20-40	0.90	87-91	ENEC	144 x 46x 30 166.5 x 46 x 30
LLC40W1100(-Z) UNI	100-240	20-40	1100	18-36	0.90	87-91	ENEC	144 x 46x 30 166.5 x 46 x 30
LLC40W1200(-Z) UNI	100-240	20-40	1200	17-33	0.90	87-91	ENEC	144 x 46x 30 166.5 x 46 x 30
LLC40W1300(-Z) UNI	100-240	20-40	1300	16-31	0.90	87-91	ENEC	144 x 46x 30 166.5 x 46 x 30
LLC40W1400(-Z) UNI	100-240	20-40	1400	14-29	0.90	87-91	ENEC	144 x 46x 30 166.5 x 46 x 30
LTC40W500(-Z) UNI	100-240	14-29	500	29-58	0.90	87-91	ENEC	108.9 x 75.4x 32 128.9 x 75.4 x 32
LTC40W600(-Z) UNI	100-240	17-35	600	29-58	0.90	87-91	ENEC	108.9 x 75.4x 32 128.9 x 75.4 x 32
LTC40W700(-Z) UNI	100-240	20-40	700	29-58	0.90	87-91	ENEC	108.9 x 75.4x 32 128.9 x 75.4 x 32
LTC40W800(-Z) UNI	100-240	20-40	800	25-50	0.90	87-91	ENEC	108.9 x 75.4x 32 128.9 x 75.4 x 32
LTC40W900(-Z) UNI	100-240	20-40	900	22-44	0.90	87-91	ENEC	108.9 x 75.4x 32 128.9 x 75.4 x 32
LTC40W1000(-Z) UNI	100-240	20-40	1000	20-40	0.90	87-91	ENEC	108.9 x 75.4x 32 128.9 x 75.4 x 32

■ **Constant Current LED drivers chart (sorting by wattage)**

Model Art.-Nr	Input voltage Nenn- spannung (VAC)	Output Ausgang			Power Factor	Efficiency (%)	Approbations Kenn-prüfzeichen	Dimension Dimension L x W x H (mm)
		Wattage Wattagen (W)	Current Ausgangsstrom (mA)	Voltage Spannung (VDC)				
LTC40W1100(-Z) UNI	100-240	20-40	1100	18-36	0.90	87-91	ENECEC	108.9 x 75.4x 32 128.9 x 75.4 x 32
LTC40W1200(-Z) UNI	100-240	20-40	1200	17-33	0.90	87-91	ENECEC	108.9 x 75.4x 32 128.9 x 75.4 x 32
LTC40W1300(-Z) UNI	100-240	20-40	1300	16-31	0.90	87-91	ENECEC	108.9 x 75.4x 32 128.9 x 75.4 x 32
LTC40W1400(-Z) UNI	100-240	20-40	1400	14-29	0.90	87-91	ENECEC	108.9 x 75.4x 32 128.9 x 75.4 x 32
LTCC40WXXLR(-Z)	220-240	28-40	500-1000	28-80	0.90	85	ENECEC	103 x 67 x 30.5 153 x 67 x 30.5
LJLCC40W900	100-242	40	900	30-44	0.9	85	PSE	180 x 42.6 x 42.5
LTCP3140W2640(-Z) UNI	100-277	31-40	775-1500	26.67-40	0.90	80	ENECEC	67 x 103 x 30.5 67 x 153 x 30.5
LTCP3140W4161(-Z) UNI	100-277	31-40	504-960	41.67-61.54	0.90	80	ENECEC	67 x 103 x 30.5 67 x 153 x 30.5
EVO42W900LR-Z	220-240	29.7-41.4	900	33-46	0.95	89	TUV,SAA	117 x 42.5 x 24
EVO42W950LR-Z	220-240	28.5-41.8	950	30-44	0.95	89	TUV,SAA	117 x 42.5 x 24
EVO42W1000LR-Z	220-240	30-42	1000	30-42	0.95	89	TUV,SAA	117 x 42.5 x 24
EVO42W1050LR-Z	220-240	31.5-42	1050	30-40	0.95	89	TUV,SAA	117 x 42.5 x 24
LAC45W1050RT UNI	120-277	30-45	414-1050	36-46	0.90	87	cRU	360 x 30 x 26
G2 +50W1200CA	220-240	27-38	900	30-42	0.90	87	ENECEC	135 x 43 x 30 185 x 43 x 30
G2 +50W1200CA	220-240	31.5-44	1050	30-42	0.90	87	ENECEC	135 x 43 x 30 185 x 43 x 30
G2 +50W1200CA	220-240	36-50.5	1200	30-42	0.90	87	ENECEC	135 x 43 x 30 185 x 43 x 30
LTC50W500(-Z) UNI	100-277	14.5-29	500	29-58	0.90	85	ENECEC	108.9 x 75.4x 32 128.9 x 75.4 x 32
LTC50W600(-Z) UNI	100-277	17.4-34.8	600	29-58	0.90	85	ENECEC	108.9 x 75.4x 32 128.9 x 75.4 x 32
LTC50W700(-Z) UNI	100-277	20.3-40.6	700	29-58	0.90	85	ENECEC	108.9 x 75.4x 32 128.9 x 75.4 x 32
LTC50W800(-Z) UNI	100-277	23.2-46.4	800	29-58	0.90	85	ENECEC	108.9 x 75.4x 32 128.9 x 75.4 x 32
LTC50W900(-Z) UNI	100-277	24.3-50	900	27-55	0.90	85	ENECEC	108.9 x 75.4x 32 128.9 x 75.4 x 32
LTC50W1000(-Z) UNI	100-277	25-50	1000	25-50	0.90	85	ENECEC	108.9 x 75.4x 32 128.9 x 75.4 x 32
LTC50W1100(-Z) UNI	100-277	25-50	1100	22.7-45	0.90	85	ENECEC	108.9 x 75.4x 32 128.9 x 75.4 x 32
LTC50W1200(-Z) UNI	100-277	24-50	1200	20-42	0.90	85	ENECEC	108.9 x 75.4x 32 128.9 x 75.4 x 32
LTC50W1300(-Z) UNI	100-277	23.4-46.8	1300	18-36	0.90	85	ENECEC	108.9 x 75.4x 32 128.9 x 75.4 x 32
LTC50W1400(-Z) UNI	100-277	25.2-46	1400	18-33	0.90	85	ENECEC	108.9 x 75.4x 32 128.9 x 75.4 x 32
LTC50W1500(-Z) UNI	100-277	25.5-45	1500	17-30	0.90	85	ENECEC	108.9 x 75.4x 32 128.9 x 75.4 x 32
LTCP3853W3553(-Z) UNI	100-240	38-53	716-1500	35.5-53	0.90	85	ENECEC	67 x 103x 30.5 67 x 153x 30.5
LTCP3853W5376(-Z) UNI	100-240	38-53	500-1000	53-76	0.90	85	ENECEC	67 x 103x 30.5 67 x 153x 30.5
EVO50W1200LR-Z	220-240	50	1200	30-40	0.95	90	ENECEC,SAA	155 x 47.5 x 33.1
EVO50W1400LR-Z	220-240	50	1400	25-36	0.95	90	ENECEC,SAA	155 x 47.5 x 33.1
EVO60W1050LR-Z	220-240	54.6	1050	36-52	0.95	90	ENECEC,SAA	155 x 47.5 x 33.1

■ **Constant Current** LED drivers chart (sorting by wattage)

Model Art.-Nr	Input voltage Nennspannung (VAC)	Output Ausgang			Power Factor	Efficiency (%)	Approbations Kennprüfzeichen	Dimension Dimension L x W x H (mm)
		Wattage Wattagen (W)	Current Ausgangsstrom (mA)	Voltage Spannung (VDC)				
EVO60W1200LR-Z	220-240	60	1200	36-50	0.95	90	ENEC,SAA	155 x 47.5 x 33.1
EVO60W1300LR-Z	220-240	59.8	1300	33-46	0.95	90	ENEC,SAA	155 x 47.5 x 33.1
EVO60W1400LR-Z	220-240	58.8	1400	30-42	0.95	90	ENEC,SAA	155 x 47.5 x 33.1
LTC60W700(-Z) UNI	100-240	20-40	700	28-57	0.90	85	ENEC	108.9 x 75.4x 32 128.9 x 75.4 x 32
LTC60W800(-Z) UNI	100-240	22-46	800	28-57	0.90	85	ENEC	108.9 x 75.4x 32 128.9 x 75.4 x 32
LTC60W900(-Z) UNI	100-240	25-52	900	28-57	0.90	85	ENEC	108.9 x 75.4x 32 128.9 x 75.4 x 32
LTC60W950(-Z) UNI	100-240	26-54	950	28-57	0.90	85	ENEC	108.9 x 75.4x 32 128.9 x 75.4 x 32
LTC60W1000(-Z) UNI	100-240	28-57	1000	28-57	0.90	85	ENEC	108.9 x 75.4x 32 128.9 x 75.4 x 32
LTC60W1050(-Z) UNI	100-240	29-58	1050	28-57	0.90	85	ENEC	108.9 x 75.4x 32 128.9 x 75.4 x 32
LTC60W1100(-Z) UNI	100-240	30-60	1100	28-55	0.90	85	ENEC	108.9 x 75.4x 32 128.9 x 75.4 x 32
LTC60W1200(-Z) UNI	100-240	30-60	1200	25-50	0.90	85	ENEC	108.9 x 75.4x 32 128.9 x 75.4 x 32
LTC60W1300(-Z) UNI	100-240	30-60	1300	23-46	0.90	85	ENEC	108.9 x 75.4x 32 128.9 x 75.4 x 32
LTC60W1400(-Z) UNI	100-240	30-60	1400	22-43	0.90	85	ENEC	108.9 x 75.4x 32 128.9 x 75.4 x 32
LTC60W1500(-Z) UNI	100-240	30-60	1500	20-40	0.90	85	ENEC	108.9 x 75.4x 32 128.9 x 75.4 x 32

■ **Constant Voltage LED drivers chart (sorting by wattage)**

Model Art. -Nr	Input voltage Nenn- spannung (VAC)	Output Ausgang			Power Factor	Efficiency (%)	Approbations Kenn-prüfzeichen	Dimension Dimension L x W x H (mm)
		Wattage Wattagen (W)	Current Ausgangsstrom (mA)	Voltage Spannung (VDC)				
LSV3W12 UNI	100-240	0-3	250	12	0.40	64	ENEC	48.9 x 39.1 x 20
LSV3W12-Z UNI	100-240	0-3	250	12	0.40	64	ENEC	55.8 x 39 x 20
LSV3W12Z UNI	100-240	0-3	250	12	0.40	64	cRU	55.8 x 39 x 20
LSV3W24 UNI	100-240	0-3	125	24	0.40	62	ENEC	48.9 x 39.1 x 20
LSV3W24-Z UNI	100-240	0-3	125	24	0.40	62	ENEC	55.8 x 39 x 20
LFV4W24-Z UNI	100-240	0-4	167	24	0.40	72	ENEC	72.8 x 40 x 16
LFV4W24Z UNI	100-120	0-4	167	24	0.40	72	cRU	72.8 x 40 x 16
LSV4W12HSP UNI	100-277	4	330	12	0.40	70	cRU	49 x 27.2 x 20
LSV4W16HSP UNI	100-277	4	250	16	0.40	70	cRU	49 x 27.2 x 20
LSV4W24HSP UNI	100-277	4	170	24	0.40	70	cRU	49 x 27.2 x 20
LEV6W12 UNI	100-120	0-6	500	12	0.40	73	cRU	145.5 x 21 x 19
	100-240	0-6	500	12	0.40	73	ENEC	145.5 x 21 x 19
LEV6W24 UNI	100-240	0-6	250	24	0.40	77	RU	145.5 x 21 x 19
	100-240	0-6	250	24	0.40	77	ENEC	145.5 x 21 x 19
LRV6W12 UNI	100-240	0-6	500	12	0.40	81	CE	55 x 22
LMV12W12 UNI	100-240	0-12	1000	12	0.40	80	ENEC	85 x 40.4 x 22
LMV12W24 UNI	100-240	0-12	500	24	0.40	83	ENEC	85 x 40.4 x 22
LRV12W12 UNI	100-240	0-12	1000	12	0.40	80	ENEC	55 x 22
LRV12W24 UNI	100-240	0-12	500	24	0.40	80	ENEC	55 x 22
LEXV18W12	220-240	0-18	1500	12	0.55C	78	TUV	162 x 37 x 25
LEXV18W24	220-240	0-18	750	24	0.55C	80	TUV	162 x 37 x 25
LFV20W12 UNI	100-120	0-20	1670	12	0.40	74	cRU	178.2 x 45.4 x 18
	100-240	0-20	1670	12	0.40	74	ENEC	178.2 x 45.4 x 18
LFV20W24 UNI	100-120	0-20	830	24	0.40	83	cRU	178.2 x 45.4 x 18
	100-240	0-20	830	24	0.40	83	ENEC	178.2 x 45.4 x 18
LLV20W12 UNI	100-120	0-20	1670	12	0.95	79	cRU	167 x 38.4 x 29.3
	100-240	0-20	1670	12	0.95	79	ENEC	167 x 38.4 x 29.3
LLV20W24 UNI	100-120	0-20	833	24	0.95	79	cRU	167 x 38.4 x 29.3
	100-240	0-20	830	24	0.95	79	ENEC	167 x 38.4 x 29.3
LEV20W24	220-240	0-20	833	24	0.90	80	CE	123 x 37 x 30
LEV25W24	220-240	0-25	1050	24	0.90	80	CE	123 x 37 x 30
LAV30W24V	220-240	0-31.5	1250	24	0.94	80	ENEC (In applying)	235 x 30 x 21

■ **Constant Voltage LED drivers chart (sorting by wattage)**

Model Art. -Nr	Input voltage Nenn- spannung (VAC)	Output Ausgang			Power Factor	Efficiency (%)	Approbations Kenn-prüfzeichen	Dimension Dimension L x W x H (mm)
		Wattage Wattagen (W)	Current Ausgangsstrom (mA)	Voltage Spannung (VDC)				
LEXV30W12	100-240	0-30	2500	12	0.97	78	TUV	232 x 37 x 25
LEXV30W24	100-240	0-30	1250	24	0.97	80	TUV	232 x 37 x 25
LHV36W12 UNI	100-240	0-36	3000	12	0.90	80	ENEC	108.9 x 75.4 x 32
LHV36W12-Z UNI	100-240	0-36	3000	12	0.90	80	ENEC	128.9 x 75.4 x 32
LHV36W24 UNI	100-240	0-36	1500	24	0.90	80	ENEC	108.9 x 75.4 x 32
LHV36W24-Z UNI	100-240	0-36	1500	24	0.90	80	ENEC	128.9 x 75.4 x 32
LEXV40W12	100-240	0-40	3300	12	0.97	78	TUV	232 x 37 x 25
LEXV40W24	100-240	0-40	1670	24	0.97	80	TUV	232 x 37 x 25
LBV46W48 UNI	100-277	0-46	960	48	0.95	83	ENEC/RU	280 x 30 x 27.5
LHV60W12	220-240	0-60	5000	12	0.95	84	ENEC	180.7 x 88 x 35.5
LHV60W24	220-240	0-60	2500	24	0.95	87	ENEC	173.4 x 77 x 30.5
LAV60W24	220-240	0-60	2500	24	0.95	87	ENEC	280 x 30 x 21
LEXV60W12	100-240	0-60	5000	12	0.97	84	TUV	182 x 71.2 x 45
LEXV60W24	100-240	0-60	2500	24	0.97	86	TUV	182 x 71.2 x 45
LCV70W48 UNI	100-277	0-70	1460	48	0.95	85	ENEC/RU	360 x 30 x 26
LHV100W24 120	100-120	0-100	4200	24	0.95	88	cRU	180.7 x 88 x 35.5
LHV100W24	220-240	0-100	4200	24	0.95	88	ENEC	180.7 x 88 x 35.5
LAV100W24V	220-240	0-100	4166	24	0.95	91	ENEC (In applying)	360 x 30.4 x 21.5
LEXV100W12	100-240	0-100	8300	12	0.97	84	ENEC	202 x 71.2 x 45
LEXV100W24	100-240	0-100	4170	24	0.97	85	ENEC	202 x 71.2 x 45
LHV150W24	220-240	0-150	6250	24	0.98	88	ENEC	234 x 113.2 x 48.2
LHV150W36	220-240	20-150	4170	36	0.98	85	ENEC	234 x 113.2 x 48.2
LEXV150W12	100-240	0-150	12000	12	0.95	86	TUV	244 x 71.2 x 45
LEXV150W24	100-240	0-150	6000	24	0.95	88	TUV	244 x 71.2 x 45
LAV150W24V	220-240	0-150	6250	24	0.95	92	ENEC (In applying)	425 x 45 x 21.5
LRXV160W24V	100-240	0-160	6660	24	0.97	90	CE	151.7 x 132 x 66.5
LAV200W24V	220-240	0-200	8300	24	0.98	93	ENEC (In applying)	425 x 45 x 24
LAV250W24V	220-240	0-250	10400	24	0.98	92	ENEC (In applying)	425 x 48 x 35
LRXV250W24V	100-240	0-250	10400	24	0.98	90	CE	191.5 x 162 x 69
LAV320W24V	220-240	100-320	13300	24	0.98	93	ENEC (In applying)	425 x 48 x 35

■ **Constant Current** Dimmable LED drivers chart (sorting by wattage)

Model Art. -Nr	Input voltage Nennspannung (VAC)	Output Ausgang			Power Factor	Efficiency (%)	Dimming Mode Dimmmodus 0/1-10V Skinking current	Approbations Kenn-prüfzeichen	Dimension Dimension L x W x H (mm)
		Wattage Wattagen (W)	Current Ausgangsstrom (mA)	Voltage Spannung (VDC)					
LJDC5W480	100	4.7	480	8-9.3	0.55	45	10-100% Triac	PSE	148.8 x 40 x 36.5
LMTC6W350-Z	220-240	3.6-5.8	350	11-16	0.90	73	10-100% Triac	CE	85 x 40.4 x 22
LRTC9W200 120V	100-120	6.6-8	190	30-40	0.90	78	10-100% Triac	cRU	∅55 x 22
LRTC9W350 120V	100-120	6.5-9	350	18-26	0.90	78	10-100% Triac	cRU	∅55 x 22
LRTC9W500 120V	100-120	6.5-9.25	500	13-18.5	0.90	78	10-100% Triac	cRU	∅55 x 22
LRTC9W700 120V	100-120	7-9	700	10-13	0.90	78	10-100% Triac	cRU	∅55 x 22
LMTC10W200-Z	220-240	5.8-8.8	200	29-44	0.90	75	10-100% Triac	ENEC	85 x 40.4 x 22
LMTC10W250-Z	220-240	6.5-10	250	26-40	0.90	75	10-100% Triac	ENEC	85 x 40.4 x 22
LMTC10W350-Z	220-240	5.95-10.15	350	17-29	0.90	75	10-100% Triac	ENEC	85 x 40.4 x 22
LMTC10W450-Z	220-240	5.4-9	450	12-20	0.90	75	10-100% Triac	ENEC	85 x 40.4 x 22
LMTC10W500-Z	220-240	6-10	500	12-20	0.90	75	10-100% Triac	ENEC	85 x 40.4 x 22
LMTC10W600-Z	220-240	5.1-8.7	600	8.5-14.5	0.90	75	10-100% Triac	ENEC	85 x 40.4 x 22
LMTC10W700-Z	220-240	5.95-10.15	700	8.5-14.5	0.90	75	10-100% Triac	ENEC	85 x 40.4 x 22
LLTC10W350-Z	220-240	7.25-9.8	350	21-28	0.90	75	10-100% Triac	CE	112.7 x 40 x 26.4
LSTC10W150P	220-240	4.95-6.45	150	33-43	0.90	80	10-100% Triac	CE	63.3 x 40 x 23
LSTC10W200P	220-240	6.6-8.6	200	33-43	0.90	80	10-100% Triac	CE	63.3 x 40 x 23
LSTC10W250P	220-240	8.25-10.75	250	33-43	0.90	80	10-100% Triac	CE	63.3 x 40 x 23
LSTC10W350P	220-240	4.55-9.45	350	13-27	0.90	80	10-100% Triac	CE	63.3 x 40 x 23
LSTC10W500P	220-240	6-10.5	500	12-21	0.90	80	10-100% Triac	CE	63.3 x 40 x 23
LSTC10W700P	220-240	5.6-10.5	700	8-15	0.90	80	10-100% Triac	CE	63.3 x 40 x 23
LJMPC10W350	100-242	10	350	18-29	0.90	75	3-100% PWM	PSE	142.4 x 61 x 42.5
LJMPC10W700	100-242	10	700	8-21.5	0.90	75	3-100% PWM	PSE	142.4 x 61 x 42.5
LRTC13W350 120V	100-120	9-14	350	25-40	0.90	80	10-100% Triac	cRU	∅65 x 27
LRTC13W500 120V	100-120	9-13	500	18-26	0.90	80	10-100% Triac	cRU	∅65 x 27
LRTC13W700 120V	100-120	9-13	700	13-18.5	0.90	80	10-100% Triac	cRU	∅65 x 27
LSTC15W500P	220-240	10.5-15	500	21-30	0.90	80	10-100% Triac	CE	79 x 43 x 27
LSTC15W700P	220-240	9.1-14.7	700	13-21	0.90	80	10-100% Triac	CE	79 x 43 x 27
LJKT15W350	100-120	15	350	24-43	0.90	80	3-100% Triac	PSE	170 x 39.2 x 39.5
LJKT15W480	100-120	15	480	8-31.5	0.90	80	3-100% Triac	PSE	170 x 39.2 x 39.5
LJKT15W500	100-120	15	500	18-30	0.90	80	3-100% Triac	PSE	170 x 39.2 x 39.5
LJKT15W700	100-120	15	700	8-21.5	0.90	80	3-100% Triac	PSE	170 x 39.2 x 39.5

■ **Constant Current Dimmable LED drivers chart (sorting by wattage)**

Model Art.-Nr	Input voltage Nennspannung (VAC)	Output Ausgang			Power Factor	Efficiency (%)	Dimming Mode Dimmmodus 0/1-10V Skinking current	Approbations Kenn-prüfzeichen	Dimension Dimension L x W x H (mm)
		Wattage Wattagen (W)	Current Ausgangsstrom (mA)	Voltage Spannung (VDC)					
LJMPC15W700	100-242	15	700	15-26	0.90	80	3-100% PWM	PSE	142.4 x 61 x 42.5
LMTC15W300-Z	220-240	7.8-12.9	300	26-43	0.90	75	10-100% Triac	ENEC	85 x 40.4 x 22
LMTC15W350-Z	220-240	9.1-15	350	26-43	0.90	75	10-100% Triac	ENEC	85 x 40.4 x 22
LMTC15W450-Z	220-240	8.1-13.5	450	18-30	0.90	75	10-100% Triac	ENEC	85 x 40.4 x 22
LMTC15W500-Z	220-240	9-15	500	18-30	0.90	75	10-100% Triac	ENEC	85 x 40.4 x 22
LMTC15W600-Z	220-240	7.8-12.6	600	13-21	0.90	75	10-100% Triac	ENEC	85 x 40.4 x 22
LMTC15W700-Z	220-240	9.1-14.7	700	13-21	0.90	80	10-100% Triac	ENEC	85 x 40.4 x 22
LJNPC15W480(HP)	100-242	15	480	8-31.5	0.90	80	1-100% PWM	PSE	149.4 x 61 x 42.5
LJNPC15W700(HP)	100-242	15	700	8-21.5	0.90	80	1-100% PWM	PSE	149.4 x 61 x 42.5
LBC20W350-1C(Z) UNI	120-277	12.6-19.5	350	36-55.7	0.90	80	10-100% 1-10V	ENEC	94 x 44 x 30 116.4 x 44 x 30
LBC20W450-1C(Z) UNI	120-277	12.6-19.8	450	28-44	0.90	80	10-100% 1-10V	ENEC	94 x 44 x 30 116.4 x 44 x 30
LBC20W500-1C(Z) UNI	120-277	13-20	500	26-40	0.90	80	10-100% 1-10V	ENEC	94 x 44 x 30 116.4 x 44 x 30
LBC20W550-1C(Z) UNI	120-277	13.2-19.8	550	24-36	0.90	80	10-100% 1-10V	ENEC	94 x 44 x 30 116.4 x 44 x 30
LBC20W600-1C(Z) UNI	120-277	12.6-18	600	21-30	0.90	80	10-100% 1-10V	ENEC	94 x 44 x 30 116.4 x 44 x 30
LBC20W700-1C(Z) UNI	120-277	12.6-19.6	700	18-28	0.90	80	10-100% 1-10V	ENEC	94 x 44 x 30 116.4 x 44 x 30
LLTC20WXXLR-Z	220-240	12-20	300-700	18-60	0.90	80	10-100% Triac	ENEC	167 x 38.4 x 29.8
LJKTC21W480	100-120	21	480	30-44	0.90	83	3-100% Triac	PSE	170 x 39.2 x 39.5
LJMPC21W500	100-242	21	500	30-42	0.90	82	3-100% PWM	PSE	142.4 x 61 x 42.5
LJMPC21W900	100-242	21	900	17-25	0.90	82	3-100% PWM	PSE	142.4 x 61 x 42.5
LATC22W460 120V	120	16.56-21.16	460	36-46	0.95	87	10-100% Triac	CE	235 x 30 x 26
LAC24W540-1C UNI	120-277	17-24	540	31.5-44.5	0.90	87	10-100% 0/1-10V	CE	235 x 30 x 26
LEC25W500-1C(Z) UNI	100-240	16.5	500	26-33	0.90	80	10-100% 1-10V	CE	123 x 37 x 30
LEC25W540-1C(Z) UNI	100-240	17.8	540	26-33	0.90	80	10-100% 1-10V	CE	123 x 37 x 30
LEC25W600-1C(Z) UNI	100-240	19.8	600	26-33	0.90	80	10-100% 1-10V	CE	123 x 37 x 30
LEC25W700-1C(Z) UNI	100-240	21.7	700	25-31	0.90	80	10-100% 1-10V	CE	123 x 37 x 30
LEC25W720-1C(Z) UNI	100-240	22.3	720	25-31	0.90	80	10-100% 1-10V	CE	123 x 37 x 30
LEC25W840-1C(Z) UNI	100-240	24.3	840	23-29	0.90	80	10-100% 1-10V	CE	123 x 37 x 30
LEC25W900-1C(Z) UNI	100-240	23.4	900	21-26	0.90	80	10-100% 1-10V	CE	123 x 37 x 30
LEC25W1000-1C(Z) UNI	100-240	25	1000	20-25	0.90	80	10-100% 1-10V	CE	123 x 37 x 30
LEC25W1100-1C(Z) UNI	100-240	24.2	1100	18-22	0.90	80	10-100% 1-10V	CE	123 x 37 x 30
LEC25W1200-1C(Z) UNI	100-240	24	1200	16-20	0.90	80	10-100% 1-10V	CE	123 x 37 x 30

■ **Constant Current Dimmable LED drivers chart (sorting by wattage)**

Model Art.-Nr	Input voltage Nennspannung (VAC)	Output Ausgang			Power Factor	Efficiency (%)	Dimming Mode Dimmmodus 0/1-10V Skinking current	Approbations Kenn-prüfzeichen	Dimension Dimension L x W x H (mm)
		Wattage Wattagen (W)	Current Ausgangsstrom (mA)	Voltage Spannung (VDC)					
LAC27W500-1C UNI	120-277	22.5-27	500	45-55	0.90	82	10-100% 0/1-10V	cRU	360 x 30 x 26
LCC30W700-OS 120V	120	19.6-28	700	28-40	0.95	85	10-100% Triac	cRU	79.8 x 78.1 x 25.4
LBTC30WXXLR(-Z)	220-240	21-30	500-1000	21-60	0.90	85	10-100% Triac	ENEC	115 x 44 x 30 137.4 x 44 x 30
LTTC30WXXLR(-Z)	220-240	21-30	500-1000	21-60	0.90	85	10-100% Triac	ENEC	103 x 67 x 30.5 153 x 67 x 30.5
LJLTC35W700	100-120	14-35	700	20-50	0.90	83	3-100% Triac	PSE	180x 42.6 x 42.5
LJMPC35W800	100-242	35	800	32-44	0.90	83	3-100% PWM	PSE	142.4x 61 x 42.5
LJLTC35W1000	100-120	35	1000	20-35	0.90	83	3-100% Triac	PSE	180x 42.6 x 42.5
LJNPC35W700(HP)	100-242	35	700	20-50	0.90	83	1-100% PWM	PSE	169 x 61 x 42.5
LCD36W500-1C UNI	120-240	18-26.25	500	36-52.5	0.90	85	10-100% 1-10V	ENEC	73 x 45 x 32 89 x 45 x 32
LCD36W600-1C UNI	120-240	21.6-31.5	600	36-52.5	0.90	85	10-100% 1-10V	ENEC	73 x 45 x 32 89 x 45 x 32
LCD36W700-1C UNI	120-240	25.2-36.75	700	36-52.5	0.90	85	10-100% 1-10V	ENEC	73 x 45 x 32 89 x 45 x 32
LCD36W800-1C UNI	120-240	20.8-30.4	800	26-38	0.90	85	10-100% 1-10V	ENEC	73 x 45 x 32 89 x 45 x 32
LCD36W900-1C UNI	120-240	21.6-30.6	900	24-34	0.90	85	10-100% 1-10V	ENEC	73 x 45 x 32 89 x 45 x 32
LCD36W1050-1C UNI	120-240	25.2-30.45	1050	24-29	0.90	85	10-100% 1-10V	ENEC	73 x 45 x 32 89 x 45 x 32
LCD36W500-1C 120V	120	26.25 max.	500	36-52.5	0.90	85	10-100% 0-10V	cRU	73 x 45 x 32 89 x 45 x 32
LCD36W600-1C 120V	120	31.5 max.	600	36-52.5	0.90	85	10-100% 0-10V	cRU	73 x 45 x 32 89 x 45 x 32
LCD36W700-1C 120V	120	36.75 max.	700	36-52.5	0.90	85	10-100% 0-10V	cRU	73 x 45 x 32 89 x 45 x 32
LCD36W800-1C 120V	120	30.4 max.	800	26-38	0.90	85	10-100% 0-10V	cRU	73 x 45 x 32 89 x 45 x 32
LCD36W900-1C 120V	120	30.6 max.	900	24-34	0.90	85	10-100% 0-10V	cRU	73 x 45 x 32 89 x 45 x 32
LCD36W1050-1C 120V	120	30.45 max.	1050	24-29	0.90	85	10-100% 0-10V	cRU	73 x 45 x 32 89 x 45 x 32
LTC40W500-1C(Z) UNI	100-240	14-29	500	29-58	0.90	87-91	10-100% 1-10V	ENEC	108.9 x 75.4 x 32 128.9 x 75.4 x 32
LTC40W600-1C(Z) UNI	100-240	17-35	600	29-58	0.90	87-91	10-100% 1-10V	ENEC	108.9 x 75.4 x 32 128.9 x 75.4 x 32
LTC40W700-1C(Z) UNI	100-240	20-40	700	29-58	0.90	87-91	10-100% 1-10V	ENEC	108.9 x 75.4 x 32 128.9 x 75.4 x 32
LTC40W800-1C(Z) UNI	100-240	20-40	800	25-50	0.90	87-91	10-100% 1-10V	ENEC	108.9 x 75.4 x 32 128.9 x 75.4 x 32
LTC40W900-1C(Z) UNI	100-240	20-40	900	22-44	0.90	87-91	10-100% 1-10V	ENEC	108.9 x 75.4 x 32 128.9 x 75.4 x 32
LTC40W1000-1C(Z) UNI	100-240	20-40	1000	20-40	0.90	87-91	10-100% 1-10V	ENEC	108.9 x 75.4 x 32 128.9 x 75.4 x 32
LTC40W1100-1C(Z) UNI	100-240	20-40	1100	18-36	0.90	87-91	10-100% 1-10V	ENEC	108.9 x 75.4 x 32 128.9 x 75.4 x 32
LTC40W1200-1C(Z) UNI	100-240	20-40	1200	17-33	0.90	87-91	10-100% 1-10V	ENEC	108.9 x 75.4 x 32 128.9 x 75.4 x 32
LTC40W1300-1C(Z) UNI	100-240	20-40	1300	16-31	0.90	87-91	10-100% 1-10V	ENEC	108.9 x 75.4 x 32 128.9 x 75.4 x 32
LTC40W1400-1C(Z) UNI	100-240	20-40	1400	14-29	0.90	87-91	10-100% 1-10V	ENEC	108.9 x 75.4 x 32 128.9 x 75.4 x 32
LTTC40WXXLR(-Z)	220-240	28-40	500-1000	28-80	0.90	85	10-100% Triac	ENEC	103 x 67 x 30.5 153 x 67 x 30.5

■ **Constant Current Dimmable LED drivers chart (sorting by wattage)**

Model Art.-Nr	Input voltage Nennspannung (VAC)	Output Ausgang			Power Factor	Efficiency (%)	Dimming Mode Dimmmodus 0/1-10V Sinking current	Approbations Kenn-prüfzeichen	Dimension Dimension L x W x H (mm)
		Wattage Wattagen (W)	Current Ausgangsstrom (mA)	Voltage Spannung (VDC)					
LJLTC40W900	100-120	40	900	30-44	0.90	83	3-100% Triac	PSE	180x 42.6 x 42.5
LAC45W1000RT-1C UNI	120-277	30-43	1000	30-43	0.90	85	10-100% 0/1-10V	cRU	360 x 30 x 26
LAC45W1050RT-1C UNI	120-277	45	414-1050	30-43	0.90	87	10-100% 0/1-10V	cRU	360 x 30 x 26
LBD45W150 UNI	120-277	12-33	150	230-550	0.90	80	18-100% 0-10V	cRU	360 x 30 x 26
LBD45W180 UNI	120-277	15.5-37	180	65-340	0.90	80	18-100% 0-10V	cRU	360 x 30 x 26
LBD45W210 UNI	120-277	12-48	210	65-450	0.90	80	18-100% 0-10V	cRU	360 x 30 x 26
LBD45W240 UNI	120-277	12-48	240	65-450	0.90	80	18-100% 0-10V	cRU	360 x 30 x 26
LBD45W240DPS UNI	120-277	12-48	150/210/240	65-550	0.90	80	18-100% 0-10V	cRU	360 x 30 x 26
LTDC50W1500-(Z) UNI	100-277	14.5-29	500	29-58	0.90	85	10-100% DALI	ENEC	108.9 x 75.4 x 32 128.9 x 75.4 x 32
LTDC50W1500-(Z) UNI	100-277	17.4-34.8	600	29-58	0.90	85	10-100% DALI	ENEC	108.9 x 75.4 x 32 128.9 x 75.4 x 32
LTDC50W1500-(Z) UNI	100-277	20.3-40.6	700	29-58	0.90	85	10-100% DALI	ENEC	108.9 x 75.4 x 32 128.9 x 75.4 x 32
LTDC50W1500-(Z) UNI	100-277	23.2-46.4	800	29-58	0.90	85	10-100% DALI	ENEC	108.9 x 75.4 x 32 128.9 x 75.4 x 32
LTDC50W1500-(Z) UNI	100-277	24.3-50	900	27-55	0.90	85	10-100% DALI	ENEC	108.9 x 75.4 x 32 128.9 x 75.4 x 32
LTDC50W1500-(Z) UNI	100-277	25-50	1000	25-50	0.90	85	10-100% DALI	ENEC	108.9 x 75.4 x 32 128.9 x 75.4 x 32
LTDC50W1500-(Z) UNI	100-277	25-50	1100	22.7-45	0.90	85	10-100% DALI	ENEC	108.9 x 75.4 x 32 128.9 x 75.4 x 32
LTDC50W1500-(Z) UNI	100-277	24-50	1200	20-42	0.90	85	10-100% DALI	ENEC	108.9 x 75.4 x 32 128.9 x 75.4 x 32
LTDC50W1500-(Z) UNI	100-277	23.4-46.8	1300	18-36	0.90	85	10-100% DALI	ENEC	108.9 x 75.4 x 32 128.9 x 75.4 x 32
LTDC50W1500-(Z) UNI	100-277	25.2-46	1400	18-33	0.90	85	10-100% DALI	ENEC	108.9 x 75.4 x 32 128.9 x 75.4 x 32
LTDC50W1500-(Z) UNI	100-277	25.5-45	1500	17-30	0.90	85	10-100% DALI	ENEC	108.9 x 75.4 x 32 128.9 x 75.4 x 32
LADC50W1050ZIB-2C UNI	100-277	45	600-1050	20-70	0.90	86	1-100% Zigbee/DALI	CE	360 x 37.1 x 27
LJCTC56W700	100-120	28-56	700	40-80	0.85	80	10-100% Triac	PSE	205.8 x 49 x 40.5
LTC60W700-1C(Z) UNI	100-240	20-40	700	28-57	0.90	85	10-100% 1-10V	ENEC	108.9 x 75.4 x 32 128.9 x 75.4 x 32
LTC60W800-1C(Z) UNI	100-240	22-46	800	28-57	0.90	85	10-100% 1-10V	ENEC	108.9 x 75.4 x 32 128.9 x 75.4 x 32
LTC60W900-1C(Z) UNI	100-240	25-52	900	28-57	0.90	85	10-100% 1-10V	ENEC	108.9 x 75.4 x 32 128.9 x 75.4 x 32
LTC60W950-1C(Z) UNI	100-240	26-54	950	28-57	0.90	85	10-100% 1-10V	ENEC	108.9 x 75.4 x 32 128.9 x 75.4 x 32
LTC60W1000-1C(Z) UNI	100-240	28-57	1000	28-57	0.90	85	10-100% 1-10V	ENEC	108.9 x 75.4 x 32 128.9 x 75.4 x 32
LTC60W1050-1C(Z) UNI	100-240	29-58	1050	28-57	0.90	85	10-100% 1-10V	ENEC	108.9 x 75.4 x 32 128.9 x 75.4 x 32
LTC60W1100-1C(Z) UNI	100-240	30-60	1100	28-55	0.90	85	10-100% 1-10V	ENEC	108.9 x 75.4 x 32 128.9 x 75.4 x 32
LTC60W1200-1C(Z) UNI	100-240	30-60	1200	25-50	0.90	85	10-100% 1-10V	ENEC	108.9 x 75.4 x 32 128.9 x 75.4 x 32
LTC60W1300-1C(Z) UNI	100-240	30-60	1300	23-46	0.90	85	10-100% 1-10V	ENEC	108.9 x 75.4 x 32 128.9 x 75.4 x 32
LTC60W1400-1C(Z) UNI	100-240	30-60	1400	22-43	0.90	85	10-100% 1-10V	ENEC	108.9 x 75.4 x 32 128.9 x 75.4 x 32
LTC60W1500-1C(Z) UNI	100-240	30-60	1500	20-40	0.90	85	10-100% 1-10V	ENEC	108.9 x 75.4 x 32 128.9 x 75.4 x 32

■ **Constant Current** Dimmable LED drivers chart (sorting by wattage)

Model Art.-Nr	Input voltage Nennspannung (VAC)	Output Ausgang			Power Factor	Efficiency (%)	Dimming Mode Dimmmodus 0/1-10V Skinking current	Approbations Kenn-prüfzeichen	Dimension Dimension L x W x H (mm)
		Wattage Wattagen (W)	Current Ausgangsstrom (mA)	Voltage Spannung (VDC)					
LJDTP60W700	100-242	28-58.8	700	40-84	0.85	80	5-100% Triac+PWM	PSE	233.8 x 49 x 40.5
LJDPC60W700	100-242	28-58.8	700	40-84	0.85	80	5-100% PWM	PSE	233.8 x 49 x 40.5
LPVC64A4C UNI	100-277	10-19 per CH	350	30-54	0.90	80	0-100% 1-10V	CE	145.5 x 90 x 40
LPVC64A4CZ UNI	100-277	10-16 per CH	350	34-54	0.85	80	0-100% 0-10V	cRU	166.5 x 90 x 40
LPVC64A4C-Z UNI	100-277	10-19 per CH	350	30-54	0.90	80	0-100% 1-10V	CE	166.5 x 90 x 40

■ **Constant Voltage** Dimmable LED drivers chart (sorting by wattage)

Model Art.-Nr	Input voltage Nennspannung (VAC)	Output Ausgang			Power Factor	Efficiency (%)	Dimming Mode Dimmmodus 0/1-10V Skinking current	Approbations Kenn-prüfzeichen	Dimension Dimension L x W x H (mm)
		Wattage Wattagen (W)	Current Ausgangsstrom (mA)	Voltage Spannung (VDC)					
LPC46W48V1C UNI	100-277	46	960	48	0.95	80	0-100% 0/1-10V	ENEC/RU	360 x 30 x 26
LAV30W24V1C	220-240	0-30	1250	24	0.94	88	1-100% 1-10V	ENEC (In applying)	235 x 30 x 21
LAV60W24V1C	220-240	0-60	2500	24	0.95	87	1-100% 1-10V	ENEC	280 x 30 x 21
LPC60W12V3C	220-240	20 per CH	1670/CH	12	0.95	85	0-100% 1-10V	ENEC	190.6 x 129.4 x 32.5
LPV72W12V1C	220-240	12-72	6000	12	0.95	85	0-100% 1-10V	-	186 x 45.6 x 41.3
LPV72W24V1C	220-240	7.2-72	3000	24	0.95	85	10-100% 1-10V	-	186 x 45.6 x 41.3
LPC100W24V3C	220-240	33 per CH	1400/CH	24	0.95	85	0-100% 1-10V	ENEC	190.6 x 129.4 x 32.5
LAV100W24V51C	220-240	100	4166	24	0.95	90	1-100% 1-10V	ENEC (In applying)	360 x 30.4 x 21.5
LAV150W24V1C	220-240	150	6250	24	0.95	90	1-100% 1-10V	ENEC (In applying)	425 x 45 x 21.5
LRXV160W24V1C	100-240	150	6670	24	0.97	90	1-100% 1-10V	CE	151.7 x 132 x 66.5
LAV200W24V1C	220-240	200	8300	24	0.98	93	1-100% 1-10V	ENEC (In applying)	425 x 48 x 35
LAV250W24V1C	220-240	250	10400	24	0.98	92	2-100% 1-10V	ENEC (In applying)	425 x 48 x 35
LRXV250W24V1C	100-240	250	10400	24	0.98	90	1-100% 1-10V	CE	191.5 x 162 x 69
LAV320W24V1C	220-240	320	13300	24	0.98	93	2-100% 1-10V	ENEC (In applying)	425 x 48 x 35

■ Control unit

Model Art. -Nr	Quick description Schnelle beschreibung	Input voltage Nenn- spannung (VAC / VDC)	Output Ausgang		Dimming mode Dimmmodus	Approbations Kenn-prüfzeichen	Dimension Dimension L x H x M (mm)
			Wattage Wattagen (W)	Voltage Spannung (VDC)			
PWM350CC3CH	24VDC	24VDC	7 per CH	3-20	0-100% 0-10V	RU	167 x 38.4x 29.3
PWM24V3CH	12VDC 24VDC	12VDC 24VDC	16.5 per CH 33 per CH	12 24	0-100% 0-10V	RU	167 x 38.4x 29.3
PWM24V1CH	12VDC 24VDC	12VDC 24VDC	50 max. 100 max.	12 24	0-100% 0-10V	-	167 x 38.4x 29.3
PWM24V1CH280	12VDC 24VDC	12VDC 24VDC	140 280	12 24	0-100% 1-10V	-	167 x 38.4x 29.3
MC1-LED	24VDC	24VDC	31 per CH	24	0-100% 1-10V	CE	178.2 x 45.4x 16
MC1-0-10V	100~240V	100~240V	-	-	0/1-10V	ENEC	178.2 x 45.4x 16

■ Dimmer

Model Art. -Nr	Quick description Schnelle beschreibung	Dimension Dimension
EP1	1~10V dimmer, none on / off switch, current sink 25mA	L39 x W22.4x H35.6 (mm) : Hard wire Red / gray 200mm 1015#20
EP3	1~10V dimmer, on / off switch, current sink 25mA	L37.2 x W22.4x H40 (mm) : Hard wire Red / Black 145mm 1015#20
EP4	3 Step dimmer : 50%, 75%, 100%	L39 x W22.4x H30 (mm) : Hard wire Red / gray 200mm 1015#20
EP3SN	1~10V dimmer, on / off switch, current sink 25mA	L86 x W86x H45.4 (mm) : Hard wire Red / gray 200mm 1015#2
EP3SNC	1~10V dimmer, none on / off switch, current sink 25mA	L86 x W86x H45.4 (mm)

Dimmer for HEP Triac Dimming LED Drivers

■ List of Leading dimmers tested for compatibility for HEP Triac Dimming LED Drivers

Brand	Model	Dimmer Power range	Dimmer Voltage range	LRTC9Wxxx 120V	LSTC10WXXXP	LSTC15WXXXP	LMTC10Wxxx-Z
Schneider	X3104	20-400W	220-240V				
	SBD-SPL		220-240V				•
	A460	20-220W	220-240V			•	
HPM	CAT400L	10-400W	220-240V				•
	CAT300E	10-300W	230-240V				•
JUNG	266 GDE	60~600W	230V		•	•	•
Legrand	5734 62	60-400W	220-240V				•
	2810 84	20-500W	220-240V				
	6145 26	25-500W	220-240V				
	2800 80	20-500W	220-240V				
Busch	2250U	20-600W	230V				
KIWI Electronics	K010L	20-1000W	250V				•
	K004U	20-400W	250V				
CHINT	NEW7-305	20-500W	220V				
Crabtree	202693	20-1000W	220-240V				
CLIPSAL	32V 500 SERIES	20-500W	250V				•
NORTH WEST	M1500	20-300W	220-240V				•
Merlin Gerin	C86 series	20-400W	220-240V				
MK	DW480	20-400W	230-240V				•
LUTRON	MACL-153M	20-600W	120V	•			
	DV-603P	20-600W	120V	•			
	AYLV600P	20-400W	120V	•			
	NTFTU-5A	20-600W	120V				
	S-603P	20-600W	120V				
COOPER	DW480	20-400W	120V				
	DAL06P	20-400W	120V				
LEVITON	IPL06-10Z	20-600W	120V				
	IPE04-1LZ	20-400W	120V				
	6674	20-600W	120V				
	IPL06-1LZ	20-600W	120V				
HUNT Dimming	PS-600 Mark X	20-600W	120V				
LIGHTOLIER	ZP600EB	20-600W	120V				
Panasonic	WTC575251	20-500W	120V				
SCONLINE	YM-2508A	20-800W	120V				

■ List of Leading dimmers tested for compatibility for HEP Triac Dimming LED Drivers

Brand	Model	Dimmer Power range	Dimmer Voltage range	LRTC13Wxxx 120V	LMTC15Wxxx-Z LLTC20WXXXLR-Z	L TTC40WXXXLR(-Z)	LCC30W700-OS 120V
Schneider	X3104	20-400W	220-240V			•	
	SBD-SPL		220-240V		•		
	A460	20-220W	220-240V				
HPM	CAT400L	10-400W	220-240V		•	•	
	CAT300E	10-300W	230-240V		•	•	
JUNG	266 GDE	60~600W	230V		•	•	
Legrand	5734 62	60-400W	220-240V		•	•	
	2810 84	20-500W	220-240V			•	
	6145 26	25-500W	220-240V			•	
	2800 80	20-500W	220-240V			•	
Busch	2250U	20-600W	230V			•	
KIWI Electronics	K010L	20-1000W	250V		•	•	
	K004U	20-400W	250V			•	
CHINT	NEW7-305	20-500W	220V			•	
Crabtree	202693	20-1000W	220-240V			•	
CLIPSAL	32V 500 SERIES	20-500W	250V			•	
NORTH WEST	M1500	20-300W	220-240V			•	
Merlin Gerin	C86 series	20-400W	220-240V			•	
MK	DW480	20-400W	230-240V			•	
LUTRON	MACL-153M	20-600W	120V				•
	DV-603P	20-600W	120V				
	AYLV600P	20-400W	120V				
	NTFTU-5A	20-600W	120V				•
	S-603P	20-600W	120V	•			
COOPER	DW480	20-400W	120V	•			
	DAL06P	20-400W	120V	•			
LEVITON	IPL06-10Z	20-600W	120V				•
	IPE04-1LZ	20-400W	120V				•
	6674	20-600W	120V				•
	IPL06-1LZ	20-600W	120V				•
HUNT Dimming	PS-600 Mark X	20-600W	120V				•
LIGHTOLIER	ZP600EB	20-600W	120V				•
Panasonic	WTC575251	20-500W	120V				•
SCONLINE	YM-2508A	20-800W	120V				•

■ List of Trailing dimmers tested for compatibility for HEP Triac Dimming LED Drivers

Brand	Model	Dimmer Power range	Dimmer Voltage range	LMTC6W350-Z	LRTC9Wxxx 120V	LSTC10WXXXXP
Schneider	SBD315RC	20-315W	230VAC			
CLIPSAL	32E450TM(450W)	10-450W	220-240V			
	32E450UDM(450W)	10-450W	220-240V			•
HPM	CAT400T(400W)	20-400W	230V			
Berker	2874(525W)	20-525W	230V			
Busch	6513U-102(420W)	20-420W	230V			•
	6519U(550W)	20-550W	230V			
JUNG	225 TDE(525W)	20-525W	230V			
Hager	WUD42(500W)	20-500W	230V			
KAOYI	KED-400A(400W)	35-400W	220-240VAC			
Etman	ETM321P	20-300W	230V	•		
	ETM327	20-300W	230V			
	ETM322P	20-500W	250V	•		
Merten	SBD315RC	20-315W	230VAC	•		
LEVITON	VPE06(600W)	20-600W	120VAC		•	
	VPE04(400W)	20-400W	120VAC		•	
LUTRON	DVELV-303P(300W)	20-300W	120VAC		•	
	SELV-300P	20-300W	120VAC		•	
LIGHTOLIER	ZP260QE(260W)	20-260W	120VAC		•	
PHILIPS	SED-200A(200W)	20-200W	230VAC			•
Legrand	Cat EM450UP	20-450W	230-240VAC			

■ List of Trailing dimmers tested for compatibility for HEP Triac Dimming LED Drivers

Brand	Model	Dimmer Power range	Dimmer Voltage range	LSTC15WXXXP	LMTc10Wxxx-Z	LRTC13Wxxx 120V
Schneider	SBD315RC	20-315W	230VAC			
CLIPSAL	32E450TM(450W)	10-450W	220-240V	•	•	
	32E450UDM(450W)	10-450W	220-240V		•	
HPM	CAT400T(400W)	20-400W	230V	•	•	
Berker	2874(525W)	20-525W	230V		•	
Busch	6513U-102(420W)	20-420W	230V	•	•	
	6519U(550W)	20-550W	230V	•		
JUNG	225 TDE(525W)	20-525W	230V	•	•	
Hager	WUD42(500W)	20-500W	230V			
KAOYI	KED-400A(400W)	35-400W	220-240VAC	•		
Etman	ETM321P	20-300W	230V			
	ETM327	20-300W	230V			
	ETM322P	20-500W	250V			
Merten	SBD315RC	20-315W	230VAC		•	
COOPER	SLC03P(600W)	20-300W	120VAC			
LEVITON	VPE06(600W)	20-600W	120VAC			•
	VPE04(400W)	20-400W	120VAC			•
LUTRON	DVELV-303P(300W)	20-300W	120VAC			•
	SELV-300P	20-300W	120VAC			•
LIGHTOLIER	ZP260QE(260W)	20-260W	120VAC			
PHILIPS	SED-200A(200W)	20-200W	230VAC			
Legrand	Cat EM450UP	20-450W	230-240VAC	•		

■ List of Trailing dimmers tested for compatibility for HEP Triac Dimming LED Drivers

Brand	Model	Dimmer Power range	Dimmer Voltage range	LMTC15Wxxx-Z LLTC20WXXXLR-Z	LBTC30WxxxLR(-Z) LTTC30WXXXLR(-Z) LTTC40WXXXLR(-Z)	LCC30W700-OS 120V
Schneider	SBD315RC	20-315W	230VAC		•	
CLIPSAL	32E450TM(450W)	10-450W	220-240V		•	
	32E450UDM(450W)	10-450W	220-240V	•	•	
HPM	CAT400T(400W)	20-400W	230V	•	•	
Berker	2874(525W)	20-525W	230V	•	•	
Busch	6513U-102(420W)	20-420W	230V	•	•	
	6519U(550W)	20-550W	230V		•	
JUNG	225 TDE(525W)	20-525W	230V	•	•	
Hager	WUD42(500W)	20-500W	230V	•	•	
KAOYI	KED-400A(400W)	35-400W	220-240VAC		•	
Etman	ETM321P	20-300W	230V			
	ETM327	20-300W	230V			
	ETM322P	20-500W	250V			
Merten	SBD315RC	20-315W	230VAC			
COOPER	SLC03P(600W)	20-300W	120VAC			
LEVITON	VPE06(600W)	20-600W	120VAC			
	VPE04(400W)	20-400W	120VAC			
LUTRON	DVELV-303P(300W)	20-300W	120VAC			•
	SELV-300P	20-300W	120VAC			
LIGHTOLIER	ZP260QE(260W)	20-260W	120VAC			
PHILIPS	SED-200A(200W)	20-200W	230VAC	• (Only LLTC20WXXXLR-Z)		
Legrand	Cat EM450UP	20-450W	230-240VAC			



Electronic Control Gear

Fluorescent Dimming Needed

HEP is the right partner bringing you all FL dimming innovations

The ability to control fluorescent lighting by pairing HEP dimming-capable ballasts with motion/occupancy detection, daylight harvesting, and building automation systems provide an excellent opportunity for business to save on energy cost while not compromise with appropriate light level and visual comfort.



Analog Dimming Mode

Fully compatible with use of triac dimmers, 0/1-10V dimmers, photocell control, occupancy sensor, HEP analog dimming control gears become an integral part of total energy management solutions

Low-Voltage (0/1-10V) Dim



Low-voltage dimmable ballasts incorporate two control leads for uses with a wide array of controllers. They optimize the benefits of such popular sustainable lighting techniques as building management system to enable maximum energy cost on saving and reduce environmental impact.

Dual Dim



It is unnecessary to carry two different types of dimming ballast in stock. Simple choice of dual-dim by actual lighting needs for phase control and/or low voltage dimming provides maximum convenience and ultra control flexibility. It is naturally ideal for use on retrofits and new construction as well.

Triac (Phase) Dim



Triac dimming ballasts provide a simpler solution without the need for additional control leads. It is so easy to bring the convenience and flexibility of application site to anywhere FL dimming is required but control leads are not already installed.

Digital Addressable Dimming Mode

Modern smart lighting technology enables maximum comforts and energy-cost saving through digital accuracy control of microprocessor. Simply engineering HEP digital control gears can achieve these benefits up to 70% savings by means of versatile lighting automation solutions.

Dali Control







Achieving a simpler way to a smarter lighting, HEP DALI dimming ballasts not only offer incredible control flexibility but also inspire greater lighting for human's better life.



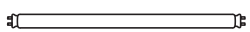
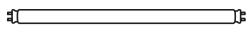

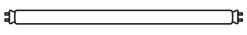

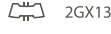
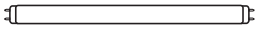
KNX Control



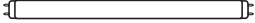





HEP KNX Intelligent control gear is naturally to fulfill demands of Building Automation Management System, smarter lighting controls maximize occupant comforts and energy savings as well.

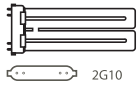
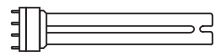

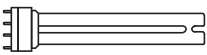
Lamp type Leuchtmitteltyp		Qty. of lamp Anzahl-leuchtmittel	Lamp wattage Lampen wattagen	Model Art. -Nr	Dimming mode Dimmmodus	Dimension Dimension L x W x H (mm)		
T5 HE	 G5	1	14,21,28,35W	ESB114-35		279 x 30.2 x 21.4		
				SD114-35	1-10V	359 x 30 x 26		
				SD114-35 UNI	1-10V	359 x 30 x 26		
				SIS114-35 UNI 21		235 x 30.2 x 20.6		
				SIS114-35 UNI S		285 x 23.5 x 20.5		
				SCL114-35 UNI		360 x 30.4 x 21.5		
				SCX114-58 UNI	KNX	360 x 30.4 x 21.5		
		2	14,21,28,35W	SD214-35	1-10V	359 x 30 x 26		
				ESB214-35		279 x 30.2 x 21.4		
				SI214-35 UNI		359 x 30 x 26		
				SD214-35 UNI	1-10V	425 x 30 x 27		
				SCL214-35 UNI	DALI	425 x 30.4 x 21.5		
		3	14W	SI3-414		360 x 30 x 26		
				SI3-414 UNI		360 x 30 x 26		
4	14W	SI3-414		360 x 30 x 26				
		SI3-414 UNI		360 x 30 x 26				
T5 HO	 G5	1	24,39W	ESB118-40		279 x 30.2 x 21.4		
				SD118-40	1-10V	359 x 30 x 26		
				SIS118-40 UNI 21		235 x 30.2 x 20.6		
				SIS118-40 UNI S		285 x 23.5 x 20.5		
				SD118-40 UNI	1-10V	359 x 30 x 26		
				SCL118-40 UNI	DALI	360 x 30.4 x 21.5		
				SCX114-58 UNI	KNX	360 x 30.4 x 21.5		
				49W	49W	ESB149		279 x 30.2 x 21.4
						SD149	1-10V	359 x 30 x 26
						SIS149 UNI S		285 x 23.5 x 20.5
				54W	54W	SCX114-58 UNI	KNX	360 x 30.4 x 21.5
						ESB154-58		279 x 30.2 x 21.4
		SD154-58	1-10V			359 x 30 x 26		
		SIS154-58 UNI 21				235 x 30.2 x 20.6		
		SIS154-58 UNI S				285 x 23.5 x 20.5		
		SD154-58 UNI	1-10V			359 x 30 x 26		
		SCL154-58 UNI	DALI	360 x 30.4 x 21.5				
		SCX114-58 UNI	KNX	360 x 30.4 x 21.5				

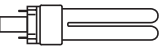
Lamp type Leuchtmitteltyp		Qty. of lamp Anzahl-Leuchtmittel	Lamp wattage Lampen wattagen	Model Art.-Nr	Dimming mode Dimmmodus	Dimension Dimension L x W x H (mm)
T5 HO	  G5	1	80W	ESB180		279 x 30.2 x 21.4
				SD180	1-10V	359 x 30 x 26
		2	24,39W	ESB218-40		279 x 30.2 x 21.4
				SD218-40	1-10V	359 x 30 x 26
				SD218-40 UNI	1-10V	425 x 30 x 27
				SCL218-40 UNI	DALI	425 x 30.4 x 21.5
			49W	ESB249		279 x 30.2 x 21.4
			54W	ESB254-58		279 x 30.2 x 21.4
				SD254-58	1-10V	359 x 30 x 26
				SI254-58 UNI		359 x 30 x 26
				SD254-58 UNI	1-10V	425 x 30 x 27
				SCL254-58 UNI	DALI	425 x 30.4 x 21.5
		80W		SI280		360 x 30 x 26
		SI280 UNI		425 x 30.2 x 26		
T5C	  2GX13	1	22,40W	ECB126-42		103 x 67 x 30.5
				TD126-42	1-10V	123 x 78x 30.5
				TC126-42E UNI		103 x 67 x 30.5
				TC126-42 UNI		126.8 x 64.5 x 27.2
		55W	ECB155		103 x 67 x 30.5	
			TD155	1-10V	123 x 78 x 30.5	
			TD155 UNI	1-10V	141.6 x 73.8 x 27.2	
		2	20,40W	ECB226-42		123 x 76.4 x 30.5
				TC226-42J UNI		141.6 x 98.3 x 27.2
				TC226-42E UNI		123 x 101.4 x 30.5
T8	  G13	1	17,25,32W	SDN117-32 UNI	0-10V+Triac	425 x 30.4 x 26.5
				SD117-32 UNI	0-10V	359 x 30 x 26
				SDT117-32 UNI	Triac	425 x 30.4 x 26.5
				SIS117-32 UNI 21		235 x 30.2 x 20.6
				SIS117-32 UNI S		285 x 23.5 x 20.5
				SCL117-32 UNI	DALI	360 x 30.4 x 21.5
				18,25,36W	ESB118-40	
		SD118-40	1-10V		359 x 30 x 26	
		SIS118-40 UNI 21			235 x 30.2 x 20.6	
		SCL118-40 UNI	DALI	360 x 30.4 x 21.5		

Lamp type Leuchtmitteltyp		Qty. of lamp Anzahl-Leuchtmittel	Lamp wattage Lampen wattagen	Model Art. -Nr	Dimming mode Dimmmodus	Dimension Dimension L x W x H (mm)	
T8	  G13	1	18,25,36W	SIS118-40 UNI S		285 x 23.5 x 20.5	
				SD118-40 UNI	1-10V	359 x 30 x 26	
			18,36W	SIS118-36I UNI		235 x 29.5 x 21	
			18,25,36,58W	SCX114-58 UNI	KNX	360 x 30.4 x 21.5	
				58W	ESB154-58		279 x 30.2 x 21.4
			SD154-58		1-10V	359 x 30 x 26	
			SIS158I UNI			235 x 29.5 x 21	
			SIS154-58 UNI 21			235 x 30.2 x 20.6	
			SIS154-58 UNI S			285 x 23.5 x 20.5	
			SD154-58 UNI		0-10V	359 x 30 x 26	
		2		17,25,32W	SDN217-32 UNI	0-10V+Triac	425 x 30.4 x 26.5
					SD217-32 UNI	0-10V	425 x 30 x 27
					SDT217-32 UNI	Triac	425 x 30.4 x 26.5
					SI217-32 UNI		359 x 30 x 26
					SCL217-32 UNI	DALI	425 x 30.4 x 21.5
				18,25,36W	ESB218-40		279 x 30.2 x 21.4
					SD218-40	1-10V	359 x 30 x 26
					SI218-40 UNI		359 x 30 x 26
					SD218-40 UNI	1-10V	359 x 30 x 26
					SCL218-40 UNI	DALI	425 x 30.4 x 21.5
58W	ESB254-58		279 x 30.2 x 21.4				
	SD254-58	1-10V	359 x 30 x 26				
	SI254-58 UNI		359 x 30 x 26				
	SD254-58 UNI	1-10V	425 x 30 x 27				
	SCL254-58 UNI	DALI	425 x 30.4 x 21.5				
T8C	  G10q	1	22,32,40W	ECB126-42		103 x 67 x 30.5	
		2	22,32,40W	ECB226-42		123 x 76.4 x 30.5	
T12	  G13	1	20,40W	SIS118-36I UNI		359 x 30 x 26	
			60W	SIS158I UNI		235 x 29.5 x 21	

Lamp type Leuchtmitteltyp		Qty. of lamp Anzahl-Leuchtmittel	Lamp wattage Lampen wattagen	Model Art.-Nr	Dimming mode Dimmmodus	Dimension Dimension L x W x H (mm)	
TC-F	 2G10	1	18,24,36W	ESB118-40		279 x 30.2 x 21.4	
				ECB126-42		103 x 67 x 30.5	
				SD118-40	1-10V	359 x 30 x 26	
				TD126-42	1-10V	123 x 78x 30.5	
				SIS118-40 UNI 21		235 x 30.2 x 20.6	
				SIS118-40 UNI S		285 x 23.5 x 20.5	
				TC126-42E UNI		103 x 67 x 30.5	
				SD118-40 UNI	1-10V	359 x 30 x 26	
				SCL118-40 UNI	DALI	360 x 30.4 x 21.5	
				SCX114-58 UNI	KNX	360 x 30.4 x 21.5	
				2	18,24W	ECB126-42	
		TC126-42E UNI				103 x 67 x 30.5	
		18,24,36W	ESB218-40				279 x 30.2 x 21.4
			SD218-40			1-10V	359 x 30 x 26
SD218-40 UNI	1-10V		425 x 30 x 27				
24,36W	SI218-40 UNI		359 x 30 x 26				
	SCL218-40 UNI	DALI	425 x 30.4 x 21.5				
TC-L	 2G11	1	18,24,36,40W	ESB118-40		279 x 30.2 x 21.4	
				ECB126-42		103 x 67 x 30.5	
				SD118-40	1-10V	359 x 30 x 26	
				TD126-42	1-10V	123 x 78x 30.5	
				TC126-42 UNI		126.8 x 64.5 x 27.2	
				TC126-42E UNI		103 x 67 x 30.5	
				SD118-40 UNI	1-10V	359 x 30 x 26	
				SIS118-40 UNI 21		235 x 30.2 x 20.6	
				SIS118-40 UNI S		285 x 23.5 x 20.5	
				SCL118-40 UNI	DALI	360 x 30.4 x 21.5	
				SCX114-58 UNI	KNX	360 x 30.4 x 21.5	
				55W(50W)	ESB154-58		279 x 30.2 x 21.4
					SD154-58	1-10V	359 x 30 x 26
		SD154-58 UNI	1-10V		359 x 30 x 26		
SIS154-58 UNI 21		235 x 30.2 x 20.6					

Lamp type Leuchtmitteltyp		Qty. of lamp Anzahl-Leuchtmittel	Lamp wattage Lampen wattagen	Model Art.-Nr	Dimming mode Dimmmodus	Dimension Dimension L x W x H (mm)	
TC-L	  G211	1	55W(50W)	SIS154-58 UNI S		285 x 23.5 x 20.5	
			55W	ECB155		103 x 67 x 30.5	
				TD155	1-10V	123 x 78 x 30.5	
				TD155 UNI	1-10V	141.5 x 73.8 x 27.2	
				ESB180		279 x 30.2 x 21.4	
				SD180	1-10V	359 x 30 x 26	
			ESB180		279 x 30.2 x 21.4		
			2	18,24W	ECB126-42		103 x 67 x 30.5
					TC126-42E UNI		103 x 67 x 30.5
				18,24,36,40W	ESB218-40		279 x 30.2 x 21.4
		SD218-40			1-10V	359 x 30 x 26	
		SI218-40 UNI				359 x 30 x 26	
		SD218-40 UNI			1-10V	425 x 30 x 27	
		SCL218-40 UNI			DALI	425 x 30.4 x 21.5	
		ESB218-40				279 x 30.2 x 21.4	
		24,36,40W		ECB226-42		123 x 76.4 x 30.5	
				TC226-42E UNI		123 x 101.4 x 30.5	
			TC226-42J UNI		141.6 x 98.3 x 27.2		
		55W(50W)	ESB254-58		279 x 30.2 x 21.4		
			SD254-58	1-10V	359 x 30 x 26		
SI254-58 UNI			359 x 30 x 26				
55W	SD254-58 UNI	1-10V	425 x 30 x 27				
55,80W	SI280		360 x 30 x 26				
	SI280 UNI		425 x 30.2 x 26				
TC-DE	  G24-1  G24-2  G24-3	1	10,13W	ECB113		103 x 67 x 30.5	
				TC113 UNI		126.8 x 64.5 x 27.2	
			18W	ECB118		103 x 67 x 30.5	
				TC118 UNI		126.8 x 64.5 x 27.2	
				TD118	1-10V	123 x 78 x 30.5	
			26W	TC124-42 UNI		103 x 67 x 30.5	
				ECB126-42		103 x 67 x 30.5	
				TD126-42	1-10V	123 x 78 x 30.5	
				TC126-42E UNI		103 x 67 x 30.5	
				TC126-42 UNI		126.8 x 64.5 x 27.2	
				TD126-42E UNI	1-10V	123 x 76.4 x 30.5	

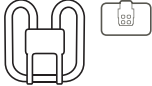
Lamp type Leuchtmitteltyp		Qty. of lamp Anzahl-Leuchtmittel	Lamp wattage Lampen wattagen	Model Art.-Nr	Dimming mode Dimmmodus	Dimension Dimension L x W x H (mm)		
TC-DE		1	26W	TD126-42 UNI	1-10V	141.6 x 73.8 x 27.2		
		2	10,13W	ECB113		103 x 67 x 30.5		
				TC113 UNI		126.8 x 64.5 x 27.2		
				TD213E UNI	1-10V	123 x 76.4 x 30.5		
			18W	ECB118		103 x 67 x 30.5		
				TD218	1-10V	123 x 76.4 x 30.5		
				26W	ECB126-42		103 x 67 x 30.5	
			ECB226-42			123 x 76.4 x 30.5		
			TD226-42		1-10V	123 x 76.4 x 30.5		
			TC126-42E UNI		103 x 67 x 30.5			
		ECB126-42		103 x 67 x 30.5				
		TC226-42E UNI		123 x 101.4 x 30.5				
		TC226-42J UNI		141.6 x 98.3 x 27.2				
		TC-TE		1	18W	ECB118		103 x 67 x 30.5
						TC118 UNI		126.8 x 64.5 x 27.2
TD118	1-10V					123 x 78x 30.5		
26,32,42W	ECB126-42					103 x 67 x 30.5		
	TD126-42				1-10V	123 x 78x 30.5		
	TC126-42E UNI					103 x 67 x 30.5		
	TC126-42 UNI					126.8 x 64.5 x 27.2		
	TD126-42E UNI				1-10V	123 x 76.4 x 30.5		
	TD126-42 UNI				0-10V	141.6 x 73.8 x 27.2		
2	18W			ECB118		103 x 67 x 30.5		
				TD218	1-10V	123 x 78x 30.5		
				TC118 UNI		126.8 x 64.5 x 27.2		
	26W			ECB126-42		103 x 67 x 30.5		
				TC126-42E UNI		103 x 67 x 30.5		
				TC126-42 UNI		126.8 x 64.5 x 27.2		
	26,32,42W			ECB226-42		123 x 76.4 x 30.5		
				TD226-42	1-10V	123 x 78x 30.5		
				TC226-42E UNI		123 x 101.4 x 30.5		
TC226-42J UNI		141.6 x 98.3 x 27.2						
2D		1	16W	ECB113		103 x 67 x 30.5		
				TC113 UNI		126.8 x 64.5 x 27.2		

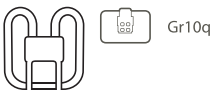
Lamp type Leuchtmitteltyp		Qty. of lamp Anzahl-Leuchtmittel	Lamp wattage Lampen wattagen	Model Art. -Nr	Dimming mode Dimmmodus	Dimension Dimension L x W x H (mm)
2D		1	21W	ECB118		103 x 67 x 30.5
				TD118	1-10V	123 x 78x 30.5
			38W	ECB126-42		103 x 67 x 30.5
				TD126-42	1-10V	123 x 78 x 30.5
				TC126-42E UNI		103 x 67 x 30.5
				TC126-42 UNI		126.8 x 64.5 x 27.2
		TD126-42 UNI	1-10V	141.6 x 73.8 x 27.2		
		2	16W	ECB113		103 x 67 x 30.5
				TC113 UNI		126.8 x 64.5 x 27.2
			21W	ECB118		103 x 67 x 30.5
				TD218	1-10V	123 x 78x 30.5
				TC118 UNI		126.8 x 64.5 x 27.2
			38W	ECB226-42		123 x 76.4 x 30.5
				TC226-42E UNI		123 x 101.4 x 30.5
TC226-42J UNI				141.6 x 98.3 x 27.2		

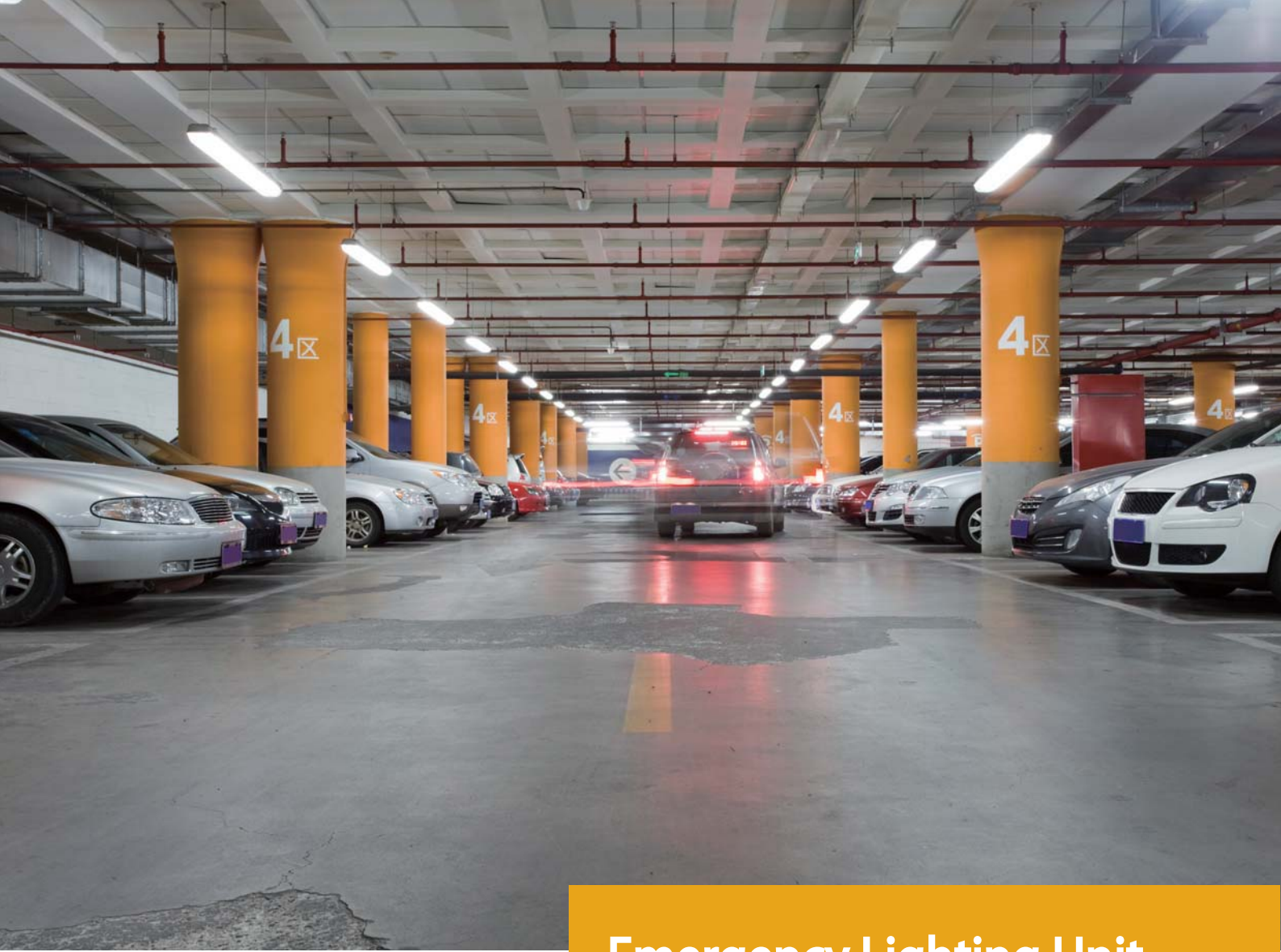

Emergency Lighting Unit

A power is always
backup you in darkness
whenever mains failed



A power is always backup you in darkness whenever mains failed

LED emergency driver works in conjunction with the AC LED driver and does not affect normal fixture operation. When normal mains fails, it immediately switch into emergency mode, operating the LEDs for a safety code-required duration from 60 to 180 minutes according to different volume of battery pack. Upon restoration of mains, the device automatically returns to the charging mode, and the battery inverter is fully restored power in 28 hours. A solid-state low voltage detection circuit protects the battery during prolonged power failures, delivering the added value of safety and compliance to a world of LED applications.



EVUL3W55 UNI		
Number Of Lamps Driven	1	
AC Input Power	3.5	W
AC Rated Input Voltage	100-240	V
AC Input Current	30	mA
AC Input Frequency	50/60	Hz
Power Factor (Full light output)	0.40	-
Emergency Mode	<70	V
Lamp Power(Emergency mode)	2.2	W
Input Power(Emergency mode)	3.5	W
Input Current(Emergency mode)	0.4	A
Operating Frequency(Emergency mode)	200	KHz
Battery Voltage	6	-
Loading Operating Ambient Temperature	+5 ~ +45	°C
Emergency Mode Ambient Temperature	0 ~ +45	°C
Max Allowed Case Temperature	+70	°C
Average Service Life	50,000	hours

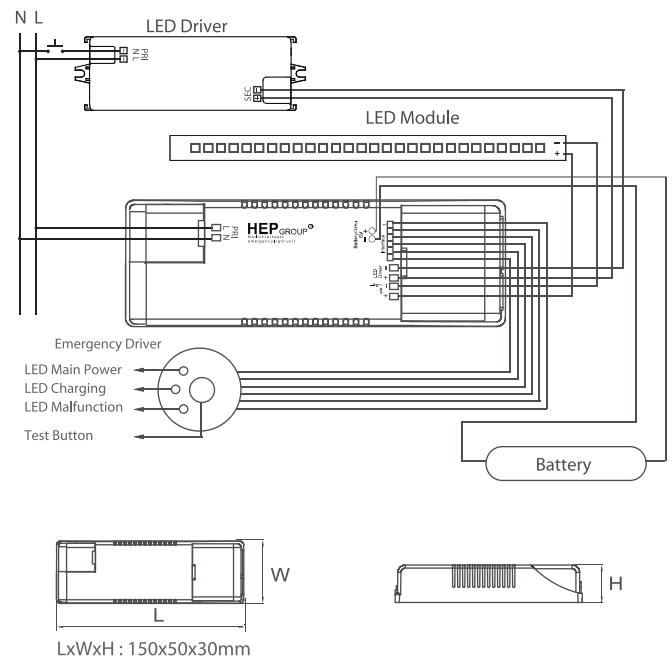



EVUL10W200 UNI		
Number Of Lamps Driven	1	
AC Input Power	10.5	W
AC Rated Input Voltage	100-277	V
AC Input Current	85	mA
AC Input Frequency	50/60	Hz
Power Factor (Full light output)	0.55	-
Emergency Mode	<70	V
Lamp Power(Emergency mode)	10	W
Input Power(Emergency mode)	12.5	W
Input Current(Emergency mode)	2.5	A
Operating Frequency(Emergency mode)	60	KHz
Battery Voltage	6	-
Loading Operating Ambient Temperature	+5 ~ +45	°C
Emergency Mode Ambient Temperature	0 ~ +70	°C
Max Allowed Case Temperature	+70	°C
Average Service Life	50,000	hours



Battery operation time @ Full Load

Current Setting	LED Forward Voltage max.	1H	3H
110 mA	50 V	2.5 Ah	7.0 Ah
110 mA	48 V	2.5 Ah	4.5 Ah
110 mA	32 V	2.5 Ah	3.0 Ah
150 mA	50 V	3.0 Ah	7.0 Ah
150 mA	45 V	2.5 Ah	7.0 Ah
150 mA	37 V	2.5 Ah	7.0 Ah
150 mA	35 V	2.5 Ah	4.5 Ah
200 mA	50 V	4.5 Ah	-
200 mA	40 V	3.0 Ah	7.0 Ah
200 mA	35 V	2.5 Ah	7.0 Ah
200 mA	28 V	2.5 Ah	7.0 Ah
200 mA	26 V	2.5 Ah	4.5 Ah

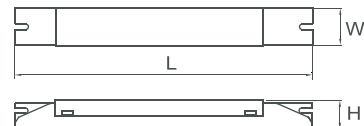

LxWxH : 235x30x21mm

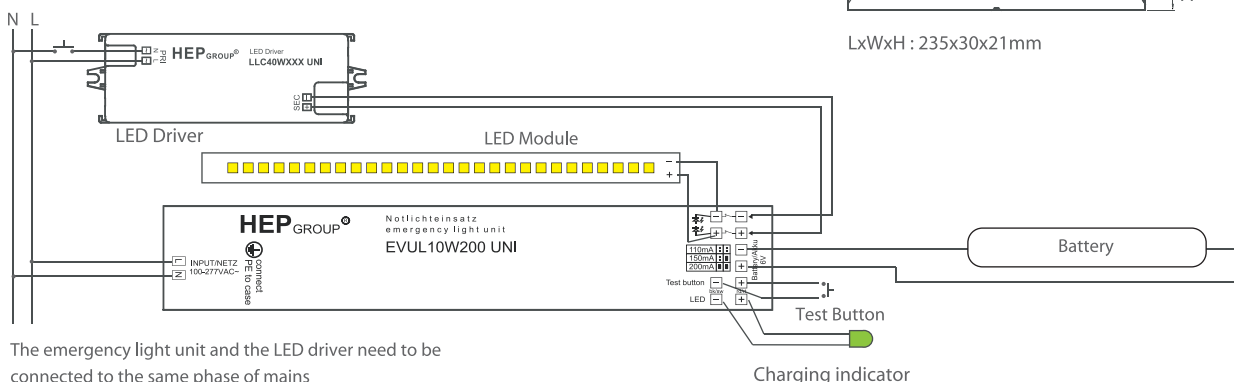

The emergency light unit and the LED driver need to be connected to the same phase of mains

Fluorescent emergency ballast

HEP one-4-all fluorescent emergency lighting unit is powerful enough for compatibility with conventional, electronic, analog or digital dimming AC ballasts, no matter how it works on 1x, 2x, 3x, 4x type of FL lighting fixture. With wide range of lamp wattages from 5W to 80W, the emergency unit fulfills all kind of applications whenever the failure of mains power it provides instant backup lighting as needed.

Features :

- Operate with conventional, electronic, dimming AC ballast in 1/2/3/4 lamp type
- Comprehensive range of lamp operation including 2-pin T5, T5C, T8, T8C and 4-pin TC-D, TC-T, TC-S, TC-L from 5W up to 80W
- Suitable for Ni-Cd and Ni-MH battery supporting discharge duration of both 1 hour on type of 2.5Ah/ 3.0Ah and 3 hours on type of 4.5Ah/ 7.0Ah
- Completely auto self-testing/self-diagnostic mode
- At intervals of 3 month battery automatically discharging and recharging to extend longer service time
- Low-voltage battery detection circuit to ensure operation of battery charging while stocking in a long period.
- LED indicator on status
 - Green/ ON: 1. normal mode; 2. charging complete
 - Green/ Flash: charging mode
 - RED/ ON: discharging mode
 - RED/ Flash: 1.battery absence; 2. battery failure

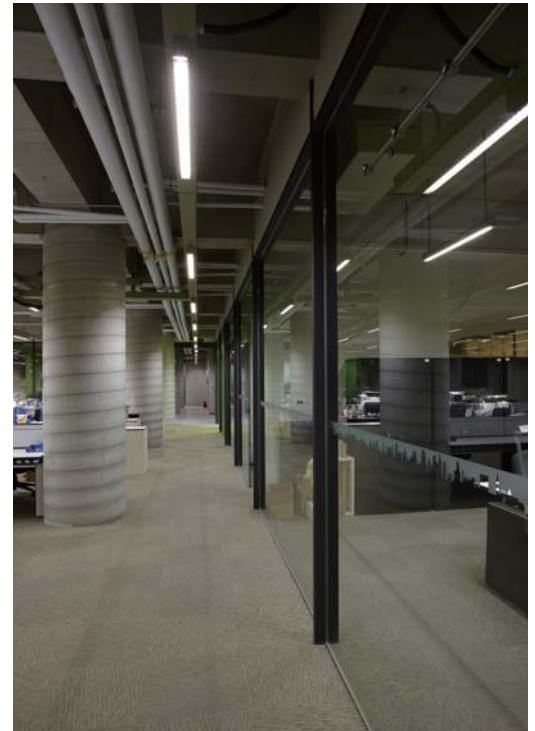

	EV-U 5-80 SW 100V	EV-U 5-80 SW	
Number Of Lamps Driven	1	1	
AC Input Power	0.3-10.5	0.3-8.5	W
AC Rated Input Voltage	100-277	220-240	V
AC Input Current	6-85	4-50	mA
AC Input Frequency	50/60	50/60	Hz
Power Factor (Full light output)	0.85	0.68	-
Emergency Mode	<70	<160	V
Lamp Power(Emergency mode)	2-12	2-12	W
Input Power(Emergency mode)	3.8-15	3.8-15	W
Input Current(Emergency mode)	0.7-2.2	0.7-2.2	A
Operating Frequency(Emergency mode)	31	31	KHz
Battery Voltage	6	6	-
Loading Operating Ambient Temperature	+5 ~ +45	+5 ~ +45	°C
Emergency Mode Ambient Temperature	0 ~ +70	0 ~ +70	°C
Max Allowed Case Temperature	+75	+75	°C
Average Service Life	60,000	50,000	hours

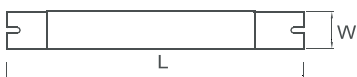

LxWxH : 235x30x21mm

Operation time chart

Lamps Leuchtmittel	Operating time Betriebsdauer	NiCd-battery NiCd-Akku	NiCd / NiMh-battery NiCd / NiMh-Akku
		2.5Ah	3.0Ah
T8	1H	18, 25, 30, 36, 38, 58 W	70 W
T8C		32, 40 W	
T5		8, 11, 14, 21, 28 W	35W
T5 High		24, 39, 54 W	49, 80 W
T5-C		22, 40, 55 W	
TC-L / TC-F		18, 24, 36, 40, 55 W	80 W
TC-DE		13, 18, 26 W	
TC-TE		18, 26, 32, 42 W	
TC-SE		5, 7, 9, 11 W	

Lamps Leuchtmittel	Operating time Betriebsdauer	NiCd / NiMh-battery NiCd / NiMh-Akku	
		4.5Ah	7.0Ah
T8	3H	18, 25, 30 W	36, 38, 58, 70 W
T8C			32, 40 W
T5		8, 11, 13, 14 W	21, 28, 35 W
T5 High		24 W	39, 49, 54, 80 W
T5-C		22 W	40, 55 W
TC-L / TC-F		18, 24 W	36, 40, 55, 80 W
TC-DE		13, 18, 26 W	
TC-TE			18, 26, 32, 42 W
TC-SE		5, 7, 9, 11 W	



Light flux in % during Emergency Operation

Lamptype	Wattage																													
Lamps Leuchtmittel	5	7	8	9	10	11	13	14	18	21	22	24	25	26	28	30	32	35	36	38	39	40	42	49	54	55	57	58	70	80
T8(T26)									18				15			15			13	13									10	8
T8C																	12					13								
T5			31			28	27	26		22					21			15												
T5 High											19										14			9	14					9
T5C											19											14				18				
TC-DE							27		26					22																
TC-L									17		17								16			14			12					8
TC-SE		31		30		28																								
TC-TE									26					18			19						16							

Battery Dimension

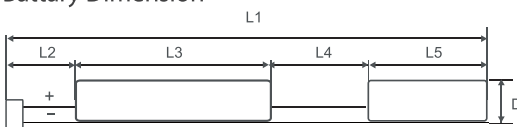

Measurement Ni-Cd Batteries

	L1	L2	L3	L4	L5	D
2,0 Ah	595	260	130	115	85	23
2,5 Ah	630	260	150	120	100	26
4,5 Ah	680	260	180	120	120	33
7,0 Ah	830	260	270	120	180	33

Measurement Ni-Mh Batteries

	L1	L2	L3	L4	L5	D
3,0 Ah	740	260	215	120	145	19
4,0 Ah	824	250	273	120	181	19.5

Features :

option1

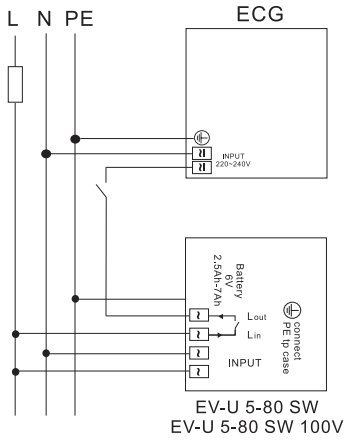

option2

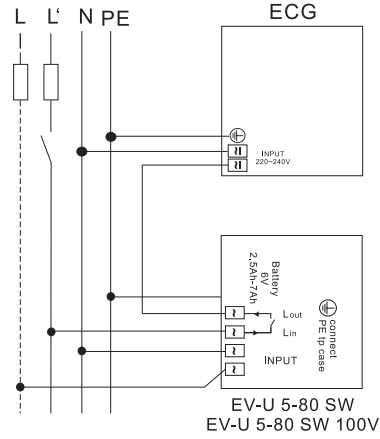

■ EVG (1-lamp with 4-pins)

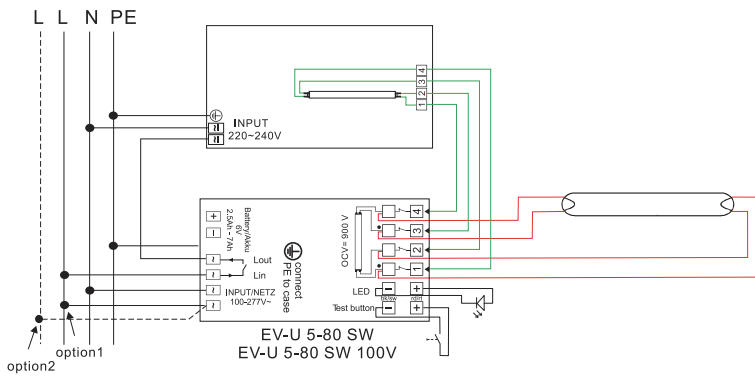

■ EVG (3-lamp with 10-pins)

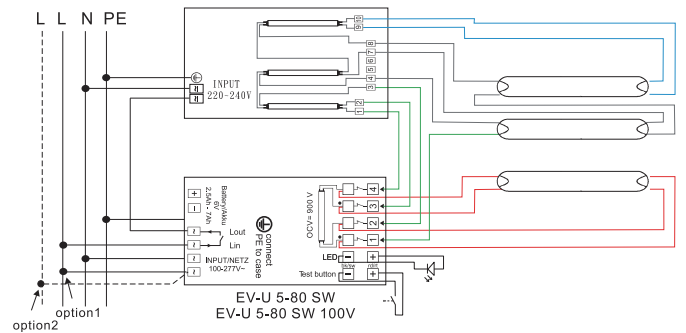

■ EVG (2-lamp with 6-pins)

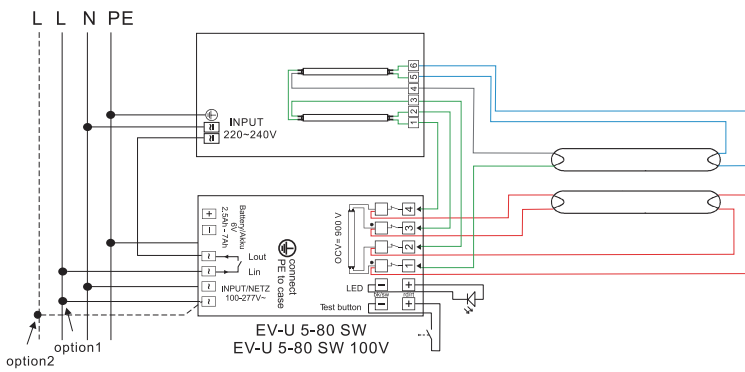

■ EVG (4-lamp with 10-pins)

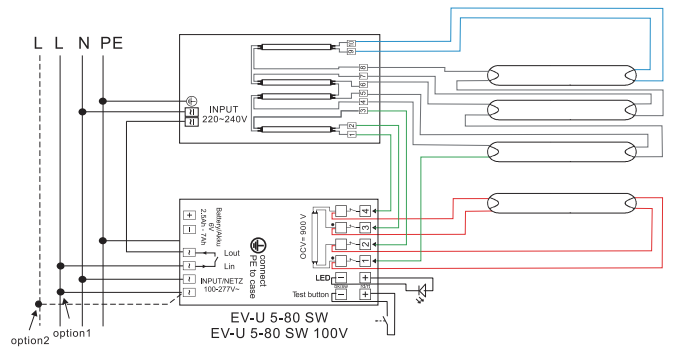

■ EVG (2-lamp with 7-pins)

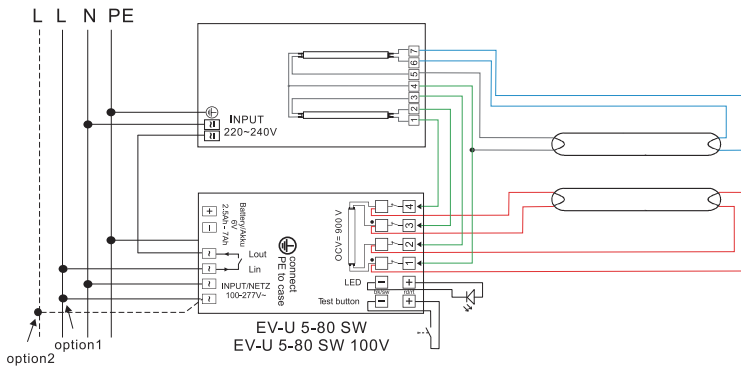

Dual-Dim HPS Electronic Ballasts



IPM plus 1~10V Dim control

With no external dimming control wire of Intelligent Power Management (IPM), SOD series smartly regulate outdoor lighting with desired dimming levels at low-traffic intervals in response to summer or winter. Multi-step dimming systems (2- or 3-step) run at 100%, 75%, 50%, or 30% on demands. SOD series effectively conserve energy to previously unattainable 50% by comparison with HPS/Magnetic ballast system.

Besides of IPM control, SOD series integrated additional 1~10 Volt dimming system offer an alternative feature of control flexibility to tune light level from 100% continuously to 30% as needed. Flexible enough for use of 1~10 Volt dimmers, photocell control, and occupancy sensor, SOD series become an integral part of total energy management system.



Features :

- Reduce lighting energy consumptions by maximum 50%
- Multi-step dimming via IPM control run at 100%, 75%, 50%, or 30%
- Continuous dimming via 1~10 Volt control from 100% down to 30%
- Ultra flexibility with 1-10V dim control or IPM but no external wire
- Support excellent lumen maintenance through all lamp life
- All-in-one compact device simplify installation and maintenance



Lamp Power (W)	Input Voltage (V)	Input Power (W)	Models	Input Frequency (Hz)	Power Factor	Operating Temp. (degC)
50	220-240	55.9	SOD50GB(-Z)	50-60	0.98	-15~+50
73	220-240	80.5	SOD70GB(-Z)	50-60	0.98	-15~+50
100	220-240	108.5	SOD100GB(-Z)	50-60	0.98	-15~+50
150	220-240	162	SOD150GB(-Z)	50-60	0.98	-15~+50
243	220-240	270	SOD250GB(-Z)	50-60	0.98	-15~+50

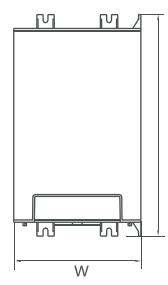

LxWxH : 192x110x44.8mm

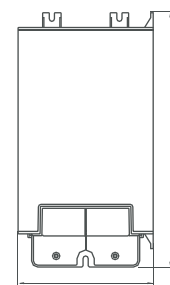

LxWxH : 207x110x44.8mm



Electronic Metal-Halide Ballasts

Beyond Performance
but Cost effective

A electronic control gear series for metal halide, 35/50/70/100/150W, is featured on lighting control via digital accuracy of modern semi-conductor technology from ignition throughout all lamp operations. Compact and slim footprint with ease of luminaires design-in enhances creativity for versatile commercial application. The gear performs outstanding lighting management and superior product reliability at more economical costs than other previous developments.



Features :

- An economical solution for standard MH lamp of 35/50/70/100/150W
- Manage consistent in output power to lamp for better lumen maintenance
- 2.5mm² large-size terminals accommodate to industrial cable
- Two ground connections furnish the installation with flexibility
- Thermally protected and lamp End-of-Life detection



Lamp Power (W)	Input Voltage (V)	Input Power (W)	Models	Input Frequency (Hz)	Power Factor	Operating Tep. (degC)
50	220-240	56	SH50GB(-Z)	50-60	0.97	-15~+50
73	220-240	80	SH70GB(-Z)	50-60	0.98	-15~+50
100	220-240	109	SH100GB(-Z)	50-60	0.95	-15~+50
150	220-240	165	SH150GB(-Z)	50-60	0.95	-15~+50

SH50/70GB : LxWxH : 108.9x75.4x32mm
SH100/150GB : LxWxH : 175.4x88x36mm

SH50/70GB(-Z) : LxWxH : 128.9x75.4x32mm
SH100/150GB(-Z) : LxWxH : 191x88x36mm

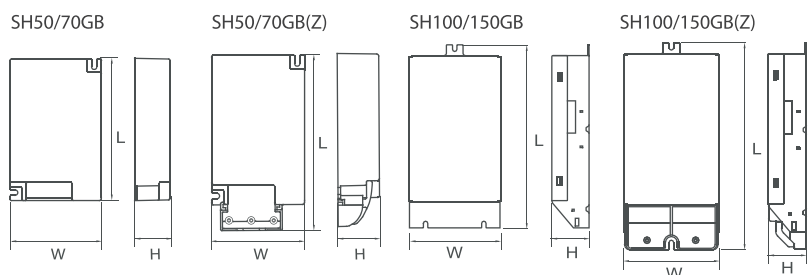



Dimmable HPS Electronic Ballasts

IPM Dimming Technology

HEP SOHxxGB series are tailored to fully address outdoor lighting demands of SON 50W, 70W, 100W, 150W featured with high efficiency of energy saving to replace magnetic system. SOH 50/70/100/150 GB electronic gear provides an opportunity boosts exceptional energy savings from the existing SON lighting in magnetic Ballast system up to maximum 30%.

Integrated function of multi-level dimming runs at 100%, 75%, 50%, SOHxxGB IPM ballast significantly cuts energy consumptions to previously unattainable 50% in comparison of non-dimmable ballast system. In addition, unnecessarily using a timer or manual switch, SOHxxGB Intelligent Power Management automatically controls outdoor lighting at varied dimming levels in response to pre-scheduled low-traffic time internals.

Simply incorporating HEP SOH 50/70/100/150 GB with IPM intelligent dimming control in SON lighting for replacement of magnetic control gear can achieve double benefits of overall 60%~80% energy saving.



Features :

- A cost effective solution to replace standard SON 50W, 70W, 100W, 150W magnetic ballast system
- Reduce lighting energy consumptions via intelligent controlled dimming by maximum 50%
- Multi-step (2-step or 3-step) dimming levels run at 100%, 75%, 50%
- Support excellent lumen maintenance through all lamp life
- All-in-one compact device simplify installation and maintenance



Lamp Power (W)	Input Voltage (V)	Input Power (W)	Models	Input Frequency (Hz)	Power Factor	Operating Tep. (degC)
50	220-240	55.9	SOH50GB(IPM)	50-60	0.98	-15~+50
73	220-240	80.5	SOH70GB(IPM)	50-60	0.98	-15~+50
100	220-240	108.5	SOH100GB(IPM)	50-60	0.98	-15~+50
150	220-240	162	SOH150GB(IPM)	50-60	0.98	-15~+50

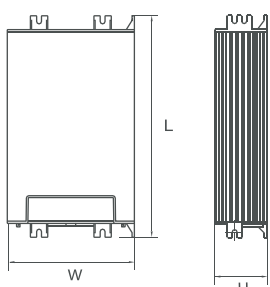

LxWxH : 192x110x44.8mm

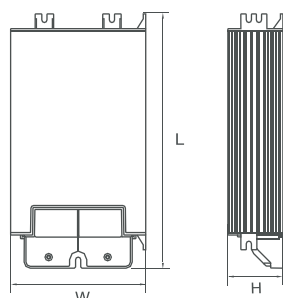

LxWxH : 207x110x44.8mm

■ HEP HID Ballast Lamp Application

Brand	Model	Lamp Holder	SH50GB (-Z)	SH70GB (-Z)	SH100GB (-Z)	SH150GB (-Z)
Philips	CDM-T	BJB G12		•		•
	CDM-Elite-T	BJB G12		•	•	•
	CDM-T-Evolution	BJB G12	•	•		
	CDM-TD	BJB RX7S		•		•
	CDM-TC	BJB G8.5		•		
	CDM-TP	BJB PG12-2(70W) PG12-2(150W)		•		
	CDM-TC-Elite	BJB G8.5		•		
	CDM-TC-Evolution	BJB G8.5				
	CDM-R	BJB E27		•		
	CDM-R111	BJB G8.5		•		
	CDM-Tm mini	BJB PGJ5				
	CDM-Tm Elite mini	BJB GU6.5				
	HPI Pius 250W/745BU	BJB E40				
	CDM-TG	BJB GX12-1				
	MHN-TD	BJB RX7S		•		
	OSRAM Powerball Replaces Standard HCI	HQI-T	BJB GX12		•	
HQI-TS		BJB RX7S(70W) RX7S-24(150W)		•		•
HCI-T		BJB G12		•		•
HCI-TS		BJB RX7S(70W) RX7S-24(150W)				
HCI-TC		BJB G8.5		•		
HCI-E/P		BJB E27				
HCI-TT		BJB E27(70W) E40(150W)		•		
HCI-TT SUPER 4Y		BJB E27(70W) E40(150W)		•		•
HCI-TM		BJB G22(250W)				
HCI-TF		BJB G6.5				
HQI-E 150W/NDL		BJB E27(70/150W) E40(250W)				
HCI-PAR		BJB E27		•		
GE	CMH-MR16	BJB GX10				
	CMH-T	BJB G12		•		•
	CMH150/UVC/T/U/942/E40	BJB E40				•
	CMH20/T/UVC/830	BJB G6.5				
	CMH20 PAR20/UVC/830/SP	BJB E27				
	CMH20/U/PAR30	BJB E27				
	CMH35/U/PAR20/942	BJB E27				
	CMH SuperMini	BJB GU6.5				
	CMH-TC	BJB G8.5		•		
	CMH-TT	BJB E40		•		
SYLVANIA	CMI-T	BJB GX10		•		•
	BriteSpot ES50	BJB GX10				
YODN	CDM-T	BJB G12				•
VENTURE	CM-PLUS TC	BJB G8.5				
	MH70W/U/PS	BJB E26		•		

■ HEP HPS Ballast Lamp Application

Brand	Model	Lamp Holder	SOH50GB (IPM)	SOH70GB (IPM)	SOH100GB (IPM)	SOH150GB (IPM)
Philips	MASTER SON-T PIA PLUS	BJB E27(50W/70W) E40(100W / 150W / 250W)	•	•	•	•
	SON-T PLUS	BJB E27(50W/70W) E40(100W / 150W)	•	•	•	•
	SON-T PRO	BJB E27(70W) E40(150W)		•		•
	SON-T B	BJB E27(70W)		•		
	CDO-TT PLUS	BJB E27(70W) E40(100W / 150W)		•	•	•
	CPO-TW	PGZ12				
OSRAM	NAV-T SUPER 4Y	BJB E27(50W/70W) E40(100W / 150W / 250W)	•	•	•	•
	NAV-T SUPER	BJB E27(50W/70W) E40(100W / 150W)	•	•	•	•
	NAV-T 4Y	BJB E27(70W) E40(150W)		•		•
	NAV-T	BJB E27(70W) E40(150W / 250W)		•		•
	NAV-E SUPER 4Y	BJB E40 (100W / 150W)			•	•
	NAV-E SUPER	BJB E27(50W/70W) E40(100W / 150W)	•	•	•	•
	NAV-E 4Y	BJB E27(70W) E40(150W)	•	•		•
	NAV-E	BJB E27(70W) E40(150W)	•	•		•
SYLVANIA	SHP-TS	BJB E27(50W/70W) E40(100W / 150W)	•	•	•	•
	SHP-T	BJB E27		•		•
	SHP-S	BJB E27(50W/70W) E40(100W / 150W)	•	•	•	•
	CMO-TW	PGZ12				•
GE	LUCALOX® T	BJB E27(50W/70W) E40(100W / 150W / 250W)		•	•	
	LUCALOX® D	BJB E27	•	•		
	LUCALOX® XO	BJB E27(50W/70W) E40(100W)	•	•	•	
	CMH Streetwise	BJB E27(70W) E40(100W / 150W)	•	•	•	•
IWASAKI	EYE SUNLUX	BJB E40				
	EYE SDX NHT150SDX	BJB E40				• (Non-IPM)
	EYE SDX NHT70SDX	BJB E27		• (Non-IPM)		

■ HEP Dimmable HPS Ballast Lamp Application

Brand	Model	Lamp Holder	SOD50 GB (Z)	SOD70 GB (Z)	SOD100 GB (Z)	SOD150 GB (Z)	SOD250 GB (Z)
Philips	MASTER SON-T PIA PLUS	BJB E27(50W/70W) E40(100W / 150W / 250W)	•	•	•	•	•
	SON-T PLUS	BJB E27(50W/70W) E40(100W / 150W)					
	SON-T PRO	BJB E27(70W) E40(150W)					
	SON-T B	BJB E27(70W)					
	CDO-TT PLUS	BJB E27(70W) E40(100W / 150W)	•	•	•	•	
	CPO-TW	PGZ12					
OSRAM	NAV-T SUPER 4Y	BJB E27(50W/70W) E40(100W / 150W / 250W)	•	•	•	•	•
	NAV-T SUPER	BJB E27(50W/70W) E40(100W / 150W)					
	NAV-T 4Y	BJB E27(70W) E40(150W)					
	NAV-T	BJB E27(70W) E40(150W / 250W)				•	•
	NAV-E SUPER 4Y	BJB E40 (100W / 150W)					
	NAV-E SUPER	BJB E27(50W/70W) E40(100W / 150W)					
	NAV-E 4Y	BJB E27(70W) E40(150W)					
	NAV-E	BJB E27(70W) E40(150W)					
SYLVANIA	SHP-TS	BJB E27(50W/70W) E40(100W / 150W)					
	SHP-T	BJB E27					•
	SHP-S	BJB E27(50W/70W) E40(100W / 150W)					
	CMO-TW	PGZ12					
GE	LUCALOX® T	BJB E27(50W/70W) E40(100W / 150W / 250W)				•	•
	LUCALOX® D	BJB E27	•	•			
	LUCALOX® XO	BJB E27(50W/70W) E40(100W)	•	•	•		
	CMH Streetwise	BJB E27(70W) E40(100W / 150W)	•	•	•	•	
	CMH250/E/UVC/U/830/E40	BJB E40					•
	CMH250/E/UVC/U/830/E40/D	BJB E40					•
Yaming	NG70T(38)	BJB E27		•			
	NG100T(46)	BJB E40			•		
	NG150T(46)	BJB E40				•	
	NG250T(E46)	BJB E40					•



Approval and Safety Marks Prüf- und Sicherheitskennzeichen



The European conformity mark ENEC (European Norms Electrical Certification) declares that product complies with all requirements of the ENEC agenda. * Das europäische Konformitätszeichen ENEC (Europäische elektrotechnische Zertifizierungsnormung) bestätigt dem Produkt die Erfüllung aller Anforderungen der ENEC Richtlinien. *



US-american conformity marks. The device complies with all requirements of the UL/UR agenda. *
US-amerikanisches Konformitätszeichen. Das Gerät entspricht allen Anforderungen der UL/UR Richtlinien. *



Canadian conformity mark. The device complies with all requirements of the CSA requirements. *
Kanadisches Konformitätszeichen. Das Gerät entspricht allen Anforderungen der CSA Richtlinien. *



Chinese Compulsory Certificate. The device complies with all requirements of the CCC agenda. *
Chinesisches obligatorisches Prüfzertifikat. Das Gerät entspricht allen Anforderungen der CCC Richtlinien. *



Product complies with EG requirements 2004/108/EC and 2006/95/EC. EC-declarations can be requested via info@hepgmbh.de. Das Produkt entspricht den EG Richtlinien 2004/108/EC und 2006/95/EC. CE-Erklärungen können unter info@hepgmbh.de angefordert werden.



Digitally controllable device complies to all requirements of the DALI-AG, where HEP maintains a membership. Digital steuerbares Gerät erfüllt alle Anforderungen der DALI-AG, zu deren Mitgliedern auch HEP gehört.



Digitally controllable device is certified according to all requirements of the KNX Association, where HEP maintains a membership. Digital steuerbares Gerät ist entsprechend allen Anforderungen des KNX-Verbandes zertifiziert, zu deren Mitgliedern auch HEP gehört.



Product complies with all RoHs (Restriction of the use of certain Hazardous Substances in electrical and electronic equipment) requirements according to 2002/95/EG. Das Produkt entspricht allen RoHs (Beschränkung der Verwendung bestimmter gefährlicher Substanzen in Elektrik- u. Elektronikgeräten) Anforderungen gemäß 2002/95/EG.

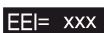

Energy consumption mark shows the device's energy efficiency class.
Energieverbrauchskennzeichnung gibt die entsprechende Energieeffizienzklasse des Gerätes an.



Product is approved for EMC by DEKRA. Das Produkt ist EMV-getestet durch das DEKRA Prüfinstitut.



Safety Extra Low Voltage. Sicherheitskleinspannung.



Safety class II device bears additional safety features like double or enhanced isolation.
Geräte der Schutzklasse II enthalten zusätzliche Schutzmerkmale wie doppelte o. verstärkte Isolierung



Short-circuit-proof isolation transformer or LED driver. Kurzschlussfester Trenntransformator oder LED Treiber.



Short-circuit-proof safety transformer or LED driver. Kurzschlussfester Sicherheits-Transformator oder LED Treiber.



Lamp is switched off at end-of-life. Leuchtmittel wird zum Ende der Lebensdauer abgeschaltet.



Device can be mounted on normally flammable surfaces as wood(-based) materials.
Das Gerät kann auf normal entflammaren Oberflächen sowie holzartigen Materialien montiert werden.



Temperature protected device. Shows max. surface temp. in the event of a fault at rated ambient temperature.
Temperaturgeschütztes Gerät. Zeigt die max. Oberflächentemperatur im Fehlerfall bei Nennumgebungstemperatur.



Can be installed in furniture made from materials with unknown flammability properties.
Kann in Möbel mit unbekanntem Entflammeigenschaften eingebaut werden



Independent device which does not have to be mounted inside a luminaire.
Unabhängiges Gerät, das nicht innerhalb einer Leuchte montiert werden muss.



Electronic control gear for emergency lighting. Elektronisches Vorschaltgerät für Notbeleuchtung



Protection against splashes from all direction. Schutz gegen Spritzwasser aus allen Richtungen.



Dimming and switching on/off by push button. Dimmen sowie Ein- und Ausschalten mittels Taster.

HEP Tech Co., Ltd.

20 Jingke 7th Rd., Nantun Dist.,
Taichung 408, Taiwan
Tel: 886-4-35009325
Fax: 886-4-35009327
www.hepgroup.net
sales@hep-tech.com.tw

HEP GmbH Hightech Electronic Products

Ramsloh 10
D - 58579 Schalksmühle
Germany
Tel: +49 (0) 2355-50919-0
Fax: +49 (0) 2355-50919-99
www.hepgmbh.de
info@hepgmbh.de

HEP Group USA Inc.

6740 Los Verdes Drive #6,
Rancho Palos Verdes,
CA 90275, USA
Tel: +1 310 - 968 - 8775
+1 310 - 541 - 4563
Fax: +1 815 - 846 - 4891
www.hepgroup.net
bthwang@gmail.com



Version 2

